

Arboritecture: Foundations of Classic Design Pruning

by Dr. Kim D. Coder, Professor of Community Forestry & Tree Health Care
Warnell School of Forestry & Natural Resources, University of Georgia

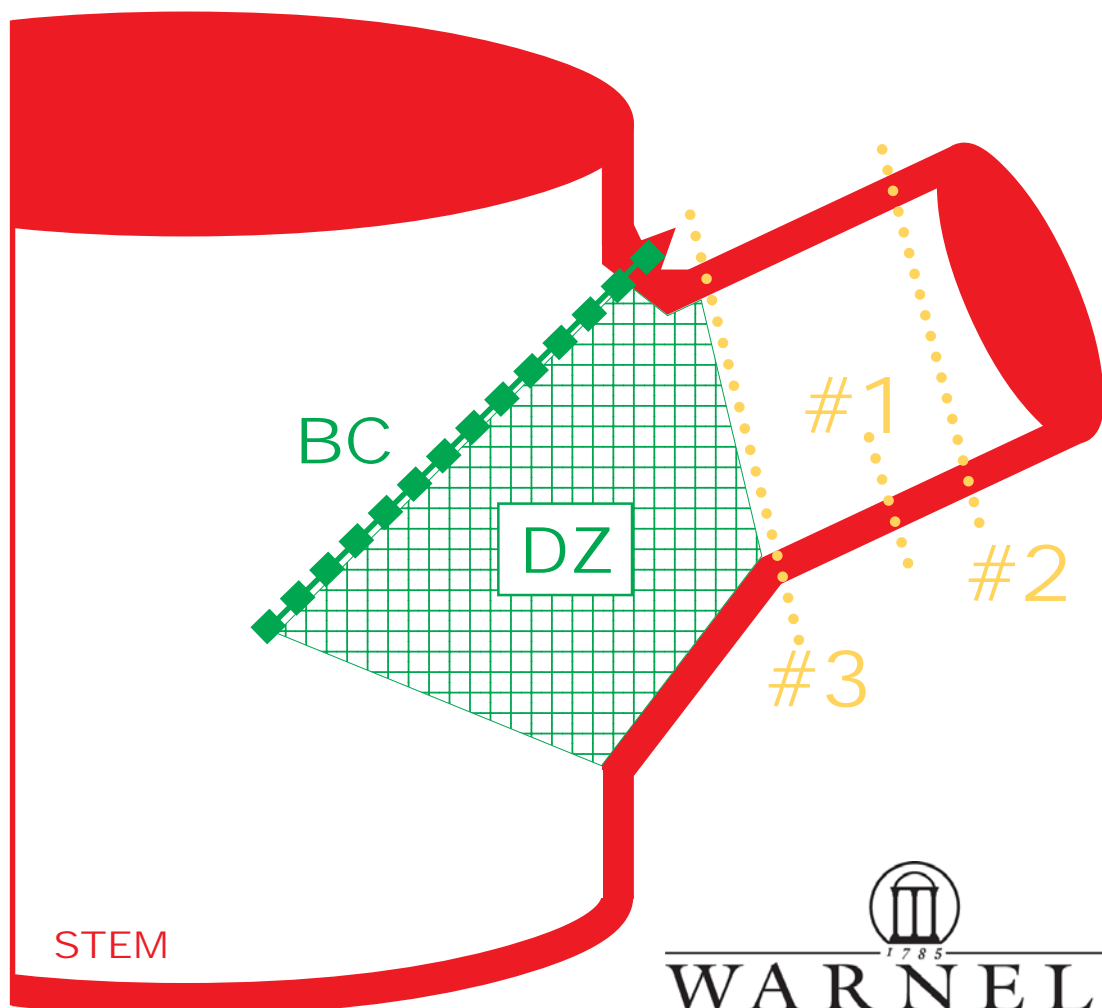

WSFNR08-13 Monograph (v. 7.1)

May 2008

In compliance with federal law, including the provisions of Title IX of the Education Amendments of 1972, Title VI of the Civil Rights Act of 1964, Sections 503 and 504 of the Rehabilitation Act of 1973, and the Americans with Disabilities Act of 1990, the University of Georgia does not discriminate on the basis of race, sex, religion, color, national or ethnic origin, age, disability, or military service in its administration of educational policies, programs, or activities; its admissions policies; scholarship and loan programs; athletic or other University-administered programs; or employment. In addition, the University does not discriminate on the basis of sexual orientation consistent with the University non-discrimination policy. Inquiries or complaints should be directed to the director of the Equal Opportunity Office, Peabody Hall, 290 South Jackson Street, University of Georgia, Athens, GA 30602. Telephone 706-542-7912 (V/TDD). Fax 706-542-2822. AN EQUAL OPPORTUNITY / AFFIRMATIVE ACTION INSTITUTION.

This publication is an educational product designed for helping tree professionals appreciate and understand a number of unique basic aspects of young tree pruning. This product is a synthesis and integration of research and educational concepts regarding trees and how pruning impacts tree biology, structure and aesthetics. This product is for awareness building and educational development. This product does not represent young tree training specifications or pruning standards.

At the time it was finished, this publication contained models of tree pruning thought by the author to provide the best means for considering fundamental tree health care issues surrounding pruning. The University of Georgia, the Warnell School of Forestry & Natural Resources, and the author are not responsible for any errors, omissions, misinterpretations, or misapplications from this educational product. The author assumed professional users would have some basic tree and pruning background. This product was not designed, nor is suited, for homeowner use. Always seek the advice and assistance of professional tree health providers for tree care.

This publication is copyrighted by the author. This educational product is only for noncommercial, nonprofit use and may not be copied or reproduced by any means, in any format, or in any media including electronic forms, without explicit written permission of the author.

Scientific Citation:

Coder, Kim D. 2008. **Arboritecture: Foundations of Classic Design Pruning**. University of Georgia Warnell School of Forestry & Natural Resources monograph publication WSFNR08-13. Pp.80.

Arboritecture:

Foundations of Classic Design Pruning

Pruning is a tool which can generate both good and bad results. It is the tree-literate arborist or tree health care specialist responsible for correctly applying pruning treatments. Pruning is used to maintain tree values, help trees appreciate in value over time, and minimize liabilities. Proper pruning increases tree owner and user value perceptions of management, minimizes structural problems, and attempts to maximize biological efficiency. Given the values which can be generated by a tree correctly pruned, it is critical to carefully consider every cut.

Training Trees & People

There are many pruning criteria and guidelines. Most organizations which deal with trees adhere to or have developed detailed tree pruning specifications. Some specifications are primarily based upon biology and structure, while others are based upon aesthetics and utility. Some specifications deal with only one management class of tree like newly planted, historic, large, or storm damaged trees. Among all pruning specifications, there are a number of common foundation principles based upon tree biology, structure, and human design aesthetics.

A key issue in correctly applying any pruning treatment is how to quickly allow new people to understand branch and stem manipulations used in reaching given tree and site management objectives. Workers with more experience may also need to be reminded about how changing scientific findings continue to impact tree pruning treatments. Educationally, the basic scientific and design foundations of tree pruning must be presented in simple mutable steps which build on each other, not a simplistic set of hard rules. Trees are pruned by the mind not a saw.

Foundations

The prescription process presented here is designed to help both novice, and more accomplished tree health care workers, be on-target when applying pruning treatments. Presented here is a pruning algorithm (a progressive step-by-step process) for understanding how and why young trees can be pruned into a biologically efficient, structurally sound, and aesthetically acceptable form. This algorithm concentrates on design pruning for young shade and street tree branches following classic architectural design. This classic design and biologically anchored pruning process is applied to the above ground portion of a tree and does not concern root pruning.

Pruning foundations built here provide for intellectual expansion to meet and exceed changing management objectives while defending tree health and structure. The complexities of individual business pruning standards and unique organizational pruning practices are left for more specific and proprietary trainings. The process outlined here is an educational tool designed to help people competently and confidently understand pruning of trees under community forest, amenity, utility, or health maintenance circumstances while meeting aesthetic targets.

Measures – Height

Most of the values people desire and appreciate from trees come from a full and well-distributed crown of leaves. A tree crown is the volume occupied by living branches, twigs and leaves

found above the top of stem or trunk. A tree crown does not include young sprouts generated by roots, stem bases, or along the otherwise branchless stem. The base of the living crown is the height above the soil surface along the stem where the first living branch is connected. A lower dead branch would not be part of a living crown measure.

There are three measures needed in discussing tree pruning applications: total tree height; live crown height; and, live crown ratio. Total tree height is the vertical distance above the soil from where the main stem is attached to the top-most stem tip. Total tree height can be easily measured with a variety of tools. It is important that lateral branches do not obscure the measurement of the top-most stem tip.

Measures – Crown

Height to the beginning of the live crown is clear stem height. Height of the entire live crown is total height of the tree minus clear stem height, or the distance between living crown base and tree top. The result is the total living crown height. Live crown ratio is a valuable measure of the photosynthetically active part of the crown divided by total tree height. The live crown ratio is used in many tree care procedures to gauge potential health, and a tree's ability to effectively react to resource changes. Live crown ratio, in other words, is what proportion of total tree height has living branches, twigs and leaves. See Figure 1.

A simple example of determining tree height and crown measures would be: a large, single stemmed, many-branched tree 40 feet in height, has living branches attached to the stem starting at 10 feet off the ground and continuing up to the tree top. Total tree height is 40 feet as given. Height to the base of the living crown is 10 feet as given. The live crown height is 30 feet (40 feet total height minus 10 feet height at base of living crown). The live crown ratio is 75% (30 feet live crown height divided by 40 feet total tree height).

Golden Trees

One of the most fabled mathematical constants used across time is the “golden proportion,” or “*phi*.” This is a value or proportion used in classical architecture, painting, sculpture, and other features of idealized human aesthetics. It has been suggested humans recognize items generated using this value inherently as properly proportioned and well-designed. The aesthetic and mathematical perceptions of the golden proportion in both the human built and natural worlds is part of our biological and cultural development. Many of the classical buildings we have preserved, and classic paintings we applaud, have been designed with *phi* in mind.

If people are asked to select a tree pruned into the “proper” shape and size, most people will select trees pruned into classic design proportions. A tree pruned into an ideal form has a living crown height comprising 61.8% of total tree height. Because of the variability in how branches and twigs are held on a tree, and where each is attached along a stem, a perfectly proportioned tree crown is impossible to attain. Instead, a design approximation can be used called a “green proportion,” or “*delta*.” A green proportion is a living crown height $\frac{2}{3}$ s (66.7%) of total tree height.

For tree crown pruning, the green proportion used here is considered close enough to the golden proportion for human design perceptions in the field. Figure 2 graphically demonstrates the golden proportion and associated golden angle used in art and architecture design. Within this tree design aesthetic, a “perfect” tree for a majority of people (both professionals and lay-people) has a clear single stem which comprises the lower $\frac{1}{3}$ of total tree height, with the other upper $\frac{2}{3}$ s of a tree comprised of a full living crown.

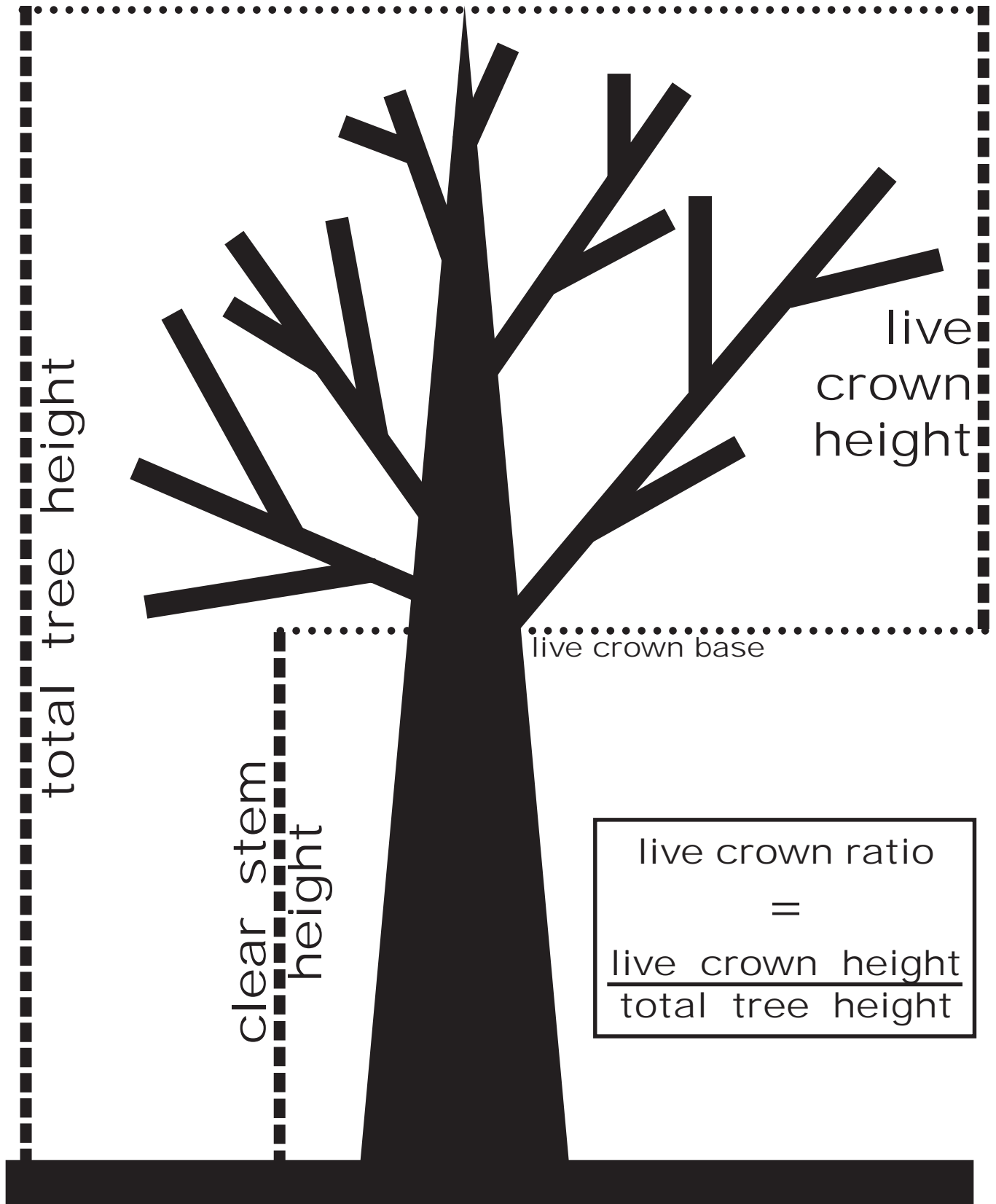

Figure 1: Diagram of various height measures in a tree and the formula for determining live crown ratio.

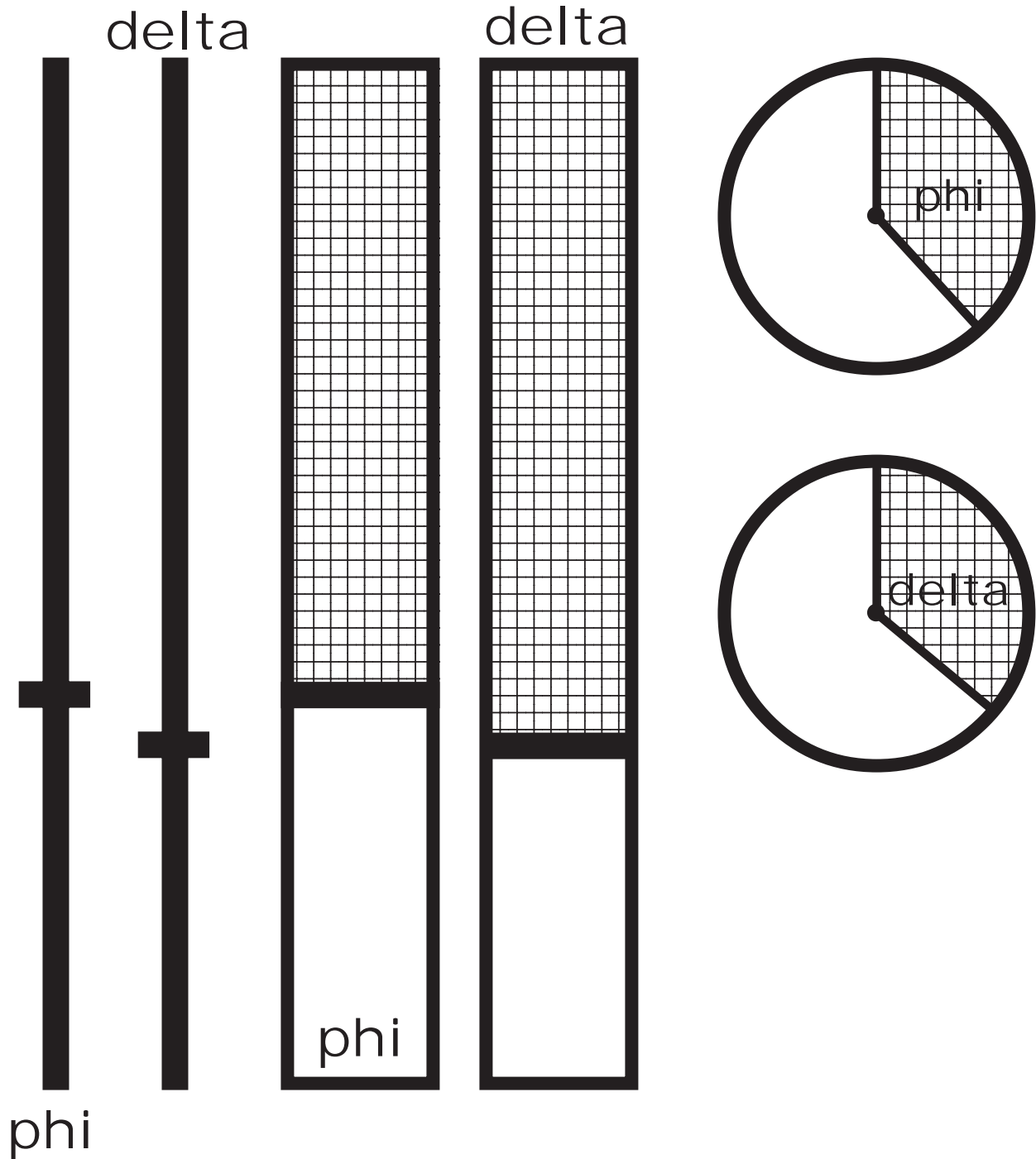

Figure 2: Graphical views of the golden proportion ($\phi = 1:1.618$) in line, block, and circular forms. The circular form is usually termed the golden angle ($\phi = 137.5^\circ$). In classic design pruning the golden proportion is replaced by a close approximation called the green proportion ($\delta = 1:1.667$) or green angle ($\delta = 135^\circ$).

Resource Space

The above ground portion of a tree occupies space from which resources can be gathered. Above-ground extent and reach of trees vary greatly. Parts of tree structure which do not meet client and health care expectations can be modified through pruning. In order to prescribe basic pruning treatments, the resource space a tree occupies and gathers resources from must be defined and visualized.

Imagine a tree within a cylinder that is as tall as the tree -- from soil surface to tree top. Cylinder diameter is the farthest horizontal reach of living branches from one side of the tree crown to the other. The tree resource space cylinder can be divided into three horizontal layers, each the thickness of one third total tree height. Each of these horizontal thirds of the cylinder could be thought of as one layer of a three-layered cake. Next, visualize each of these circular horizontal layers being divided into three equal sized wedges or pie-shaped pieces. See Figure 3.

The resource space cylinder visualized around a tree would be divided into three wedge-shaped volumes within each of three horizontal layers, yielding nine volumes of resource space within the whole tree resource space cylinder. The resource space cylinder is divided into thirds up and down its height and divided into thirds around the circumference of the cylinder. Figure 4 provides an example of a tree inside a cylindrical resource space divided into thirds horizontally and vertically. These resource spaces will be used as the basis for prescribing pruning treatments.

Lively Ratio

A live crown ratio of $2/3$ s (66.7%, green proportion, *delta*) provides the aesthetic appeal of a well-tended tree. More importantly, this live crown ratio assures ample photosynthetic surface for a potentially robust and vigorous tree, if site resources are not constrained. As live crown ratios decline, less photosynthetic area and more respiring tissue remain. For a variety of tree health care issues, live crown ratio limits have been successfully used to gauge potential tree reactions to resource changes and probability of dealing effectively with stress. For example, once upland oak species (*Quercus* spp.) approach a live crown ratio of 15%, they are more prone to insect attack (i.e. borers) and less resistant to abiotic stress. For example in Southern yellow pines (*Pinus* spp.), as live crown ratio approaches 10%, a number of bark beetles become much more effective in attack and the tree less able to resist.

Young tree pruning prescriptions should attempt to maintain a tree with about a $2/3$ s live crown ratio. This is both a biologic and an aesthetic specification to approach. Remember this green proportion crown ratio is an idealized target. Variability in crown height will always be present from tree to tree, especially trees abused or neglected in the past. The experience of a trained tree health care specialist effectively applying this green proportion to each individual case is essential. A live crown ratio less than 33% can be considered poor biologically and aesthetically. Compare Figure 5 & Figure 6.

Single Best

Living crown ratio is a key element in any pruning prescription. Another key feature is how the living crown is draped over the structure of a tree. Conserving a single, dominant vertical stem growing along the most direct path between tree top and tree base is critical. There are many reasons for maintaining multi-stem, crooked, highly branched, shaped, or forked stems aesthetically. Many of these forms result from specialty pruning or shearing processes, some of which are very management intensive. As trees age, ravages of the environment may damage structurally unsound, highly manipulated, or codominant branch and stem forms.

For most shade and street trees, an easily manageable, structurally sound and biologically efficient form is best. This pruning prescription process attempts to craft a single stem without

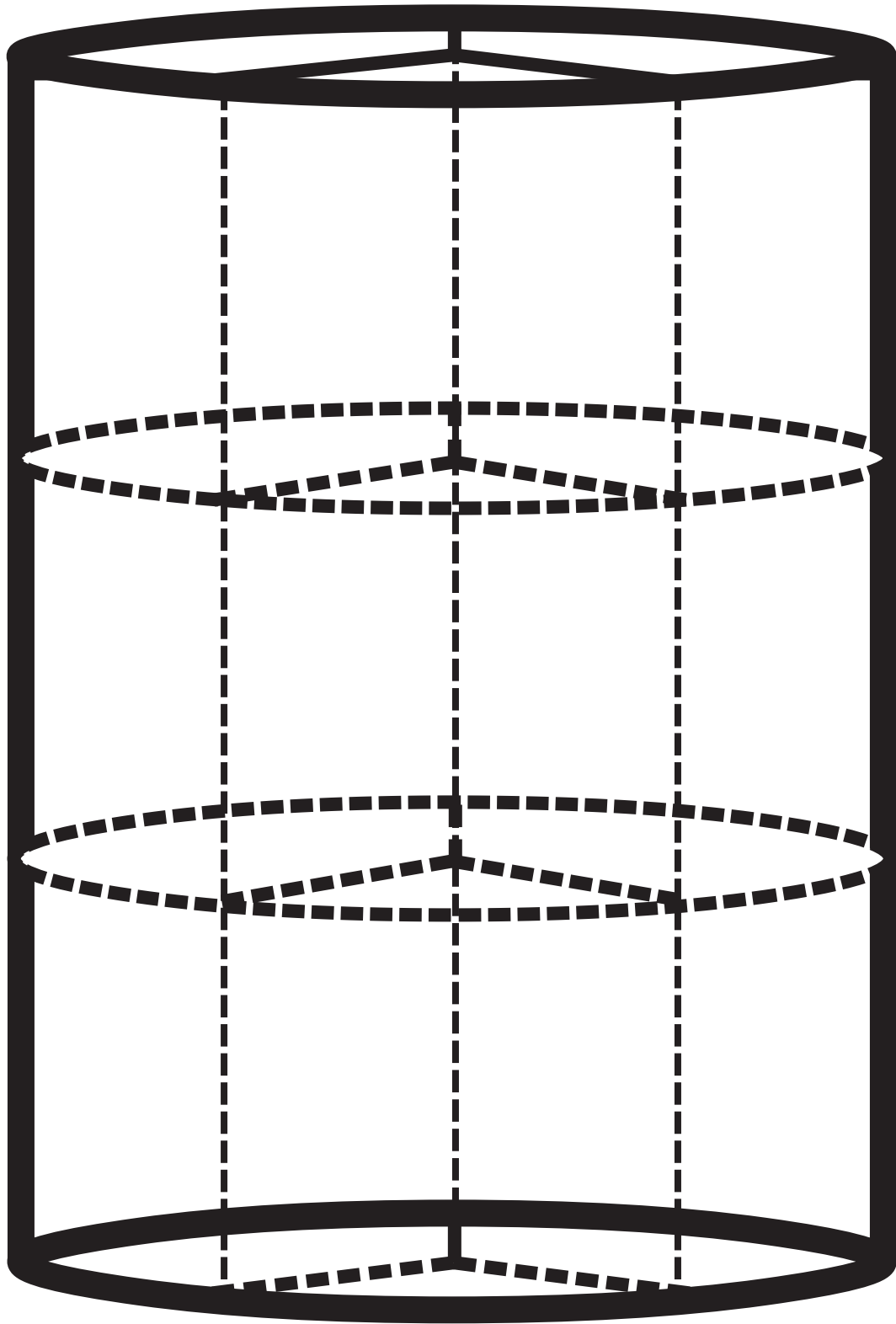

spaces of $1/3s$

Figure 3: A cylinder with the same maximum dimensions as the above-ground portion of a measured tree divided into three horizontal layers which are each divided into three wedge shaped (pie-shaped) areas.

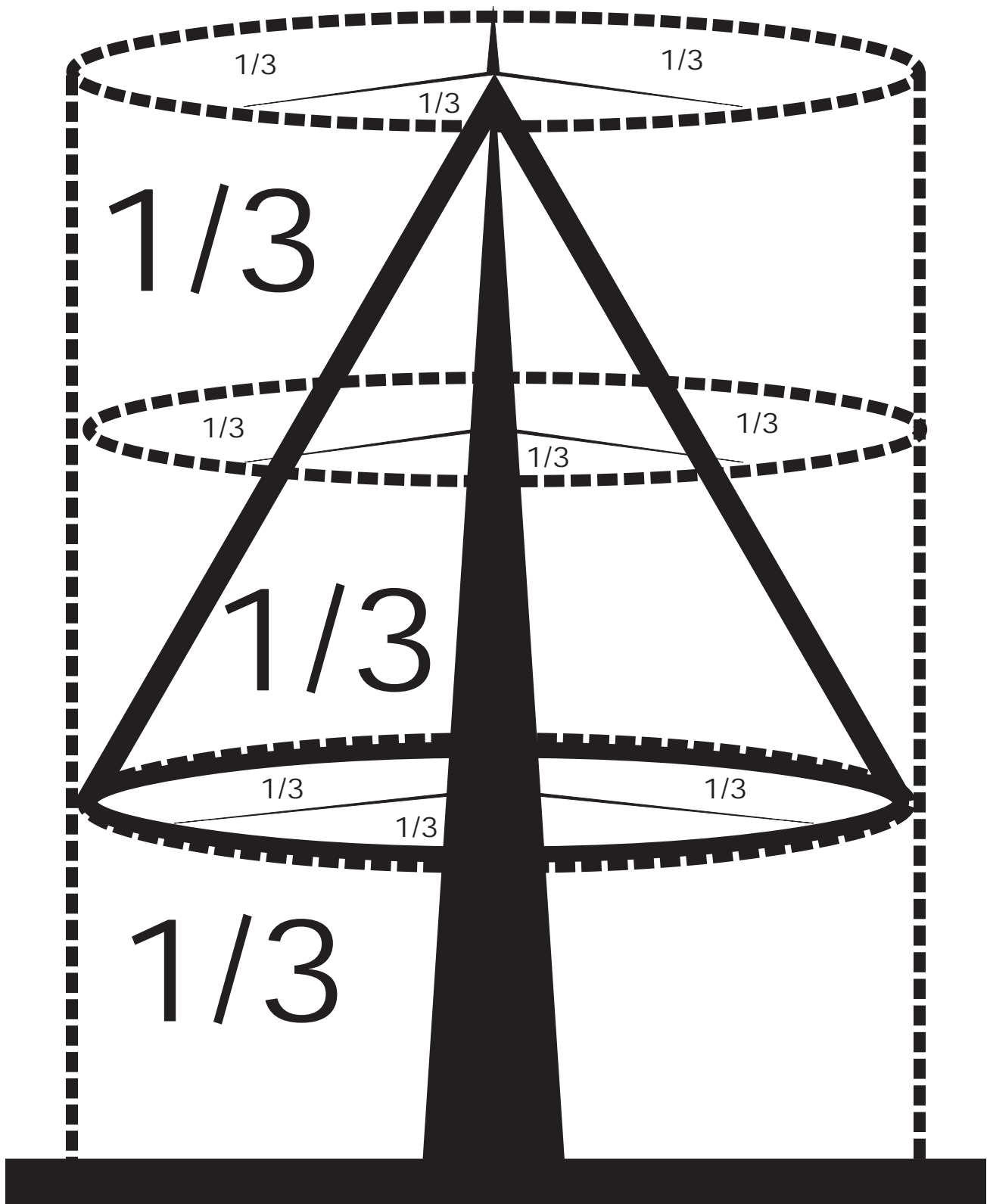

Figure 4: Diagram applying a cylinder divided into thirds horizontally and vertically over top of the above-ground portion of a tree.

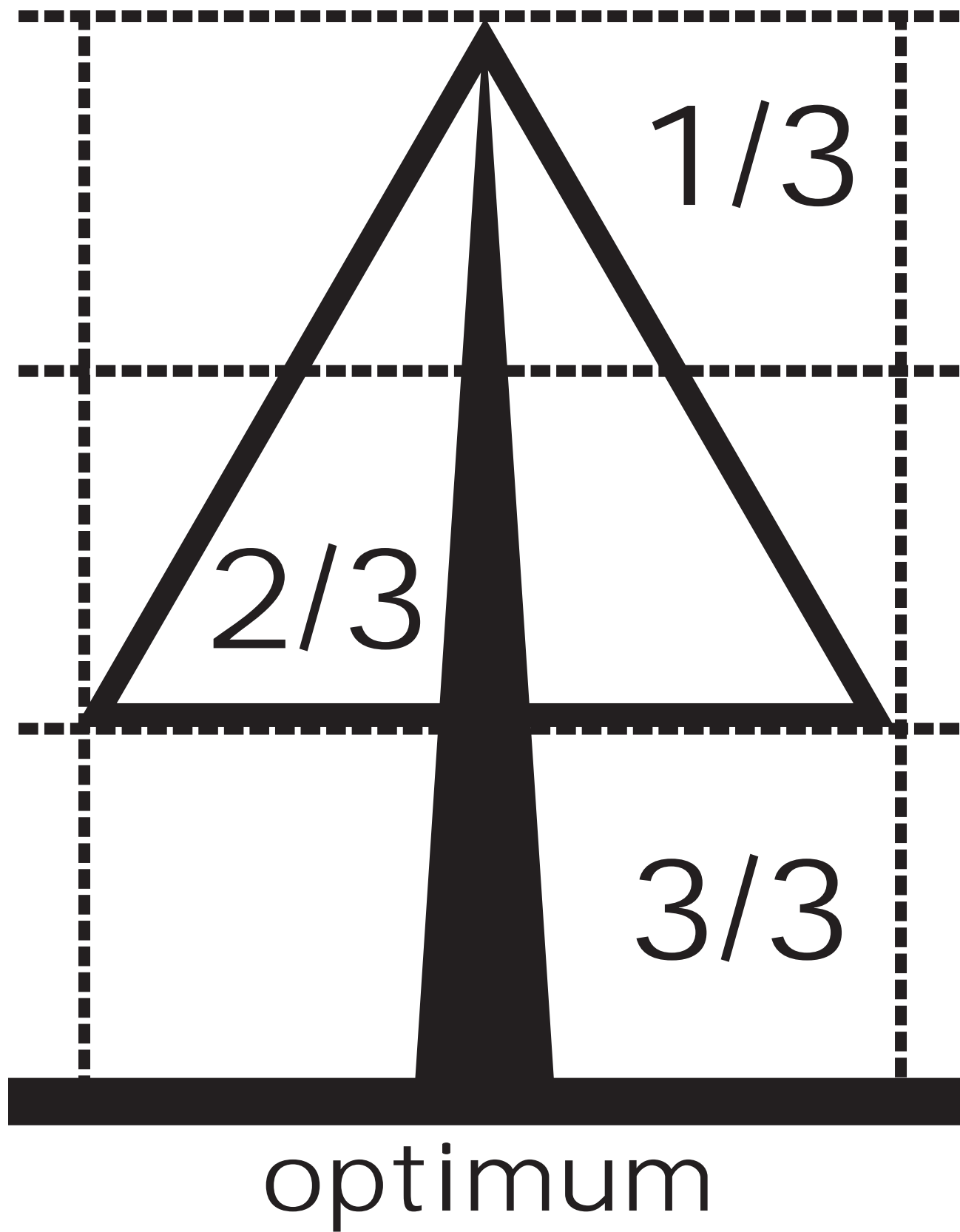

Figure 5: Diagram of optimum live crown ratio (*delta*) for a classically designed tree.

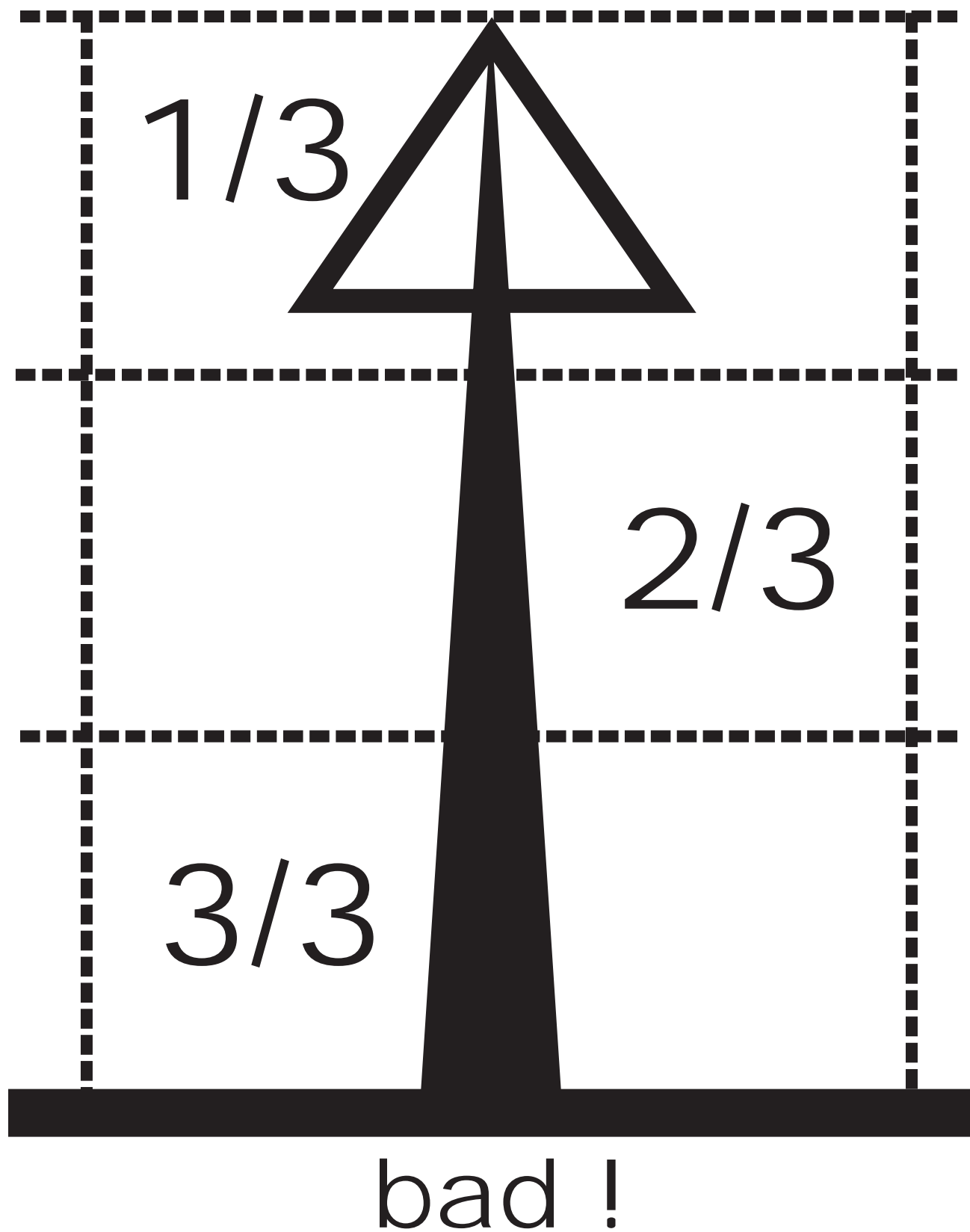

Figure 6: Diagram of a tree with a debilitating live crown ratio.

codominant or opposite branches for at least $2/3$ s of the height of the tree (half the live crown height), and, if possible, throughout the entire height of the tree. See Figure 7. Tree structure should include a straight, vertical, well-tapered, dominant stem with proportionally small branches attached along most of its height.

Architectural Quality

Proper stem and branch structure help determine potential tree longevity and health, as well as aesthetic qualities. Figure 8 is a graphical example of a tree without a single or dominant stem. In this figure there are many codominant branches (branches approaching the same diameter as the stem diameter from which they grow). This type of tree architecture has been shown to sustain storm damage over time, leading to associated structural problems including branch failure and stem decay. The defensive ability of a tree is also compromised by this branch structure. In addition, the ability to effectively allocate limited resources throughout a tree is less effective. Figure 9 in contrast, shows a proper architectural form developed by proper pruning. Any codominant branches which might exist are small and relegated to the top $1/3$ of the living tree crown.

There are five primary crown architectures in tree-form plants. Figure 10. These architectural forms develop because of the location and activities of dominant growing points or buds. From among these primary architectural crown forms come many natural and artificial shapes we associate with trees. Any of these crown shapes are modified by pruning in young trees to minimize problems later in tree life, or to meet an immediate landscape objective. A crown shape in a young tree under a pruning prescription does not (will not) necessarily represent the desired crown shape of the mature tree. Here only pruning of decurrent and excurrent native tree architectures are reviewed.

Pruning Cone

When prescribing pruning, view a tree from the side at some distance (or use a digital image or hand drawn side-silhouette). Visualize a cone (triangle in two dimensions) placed over the tree image. This cone can have various sizes depending on the height and age of the tree, as well as eventual crown form. Young trees of most crown forms usually need to be pushed into efficient upright growth patterns and away from the ground surface. A narrow pruning cone can be used as a template for training branches using reduction and removal. Figure 11.

As trees age and gain height, a wider pruning cone or template can be used, depending upon requirements for tree performance. Figure 12 provides a graphical solution to the examples shown in Figure 11. Selecting a more narrow pruning cone prescription when a tree is young will generate many biological and aesthetic values. Using a pruning cone template does NOT mean a tree should be sheared (internode cut, topped, tipped, etc.) like a hedge or Christmas tree. The cone shape is to guide branch length through proper pruning (i.e. nodal cut thinning, reduction, subordination), not provide crown shaping limits.

Cone Crowns

When using a pruning cone as a prescription guide, plan for which branches need to be reduced or removed. This process is easily computerized using digital imagery and can form a work plan document over many pruning cycles. The lowest third of the tree should not be included in the pruning cone angle used for the top $2/3$ s of the tree. Reduce the lowest branches as shown by the dotted lines in Figure 13. Branches in the lowest third of the tree are transient, adding values such as locations for food and growth regulator production, wind load shock absorbers, and environmental sensors for the tree. Figure 14 shows the use of a pruning cone guide for one side of a tree. All branches extending outside the pruning cone are candidates for proper reduction or removal.

primary single axis

(at least to 2/3
tree height)

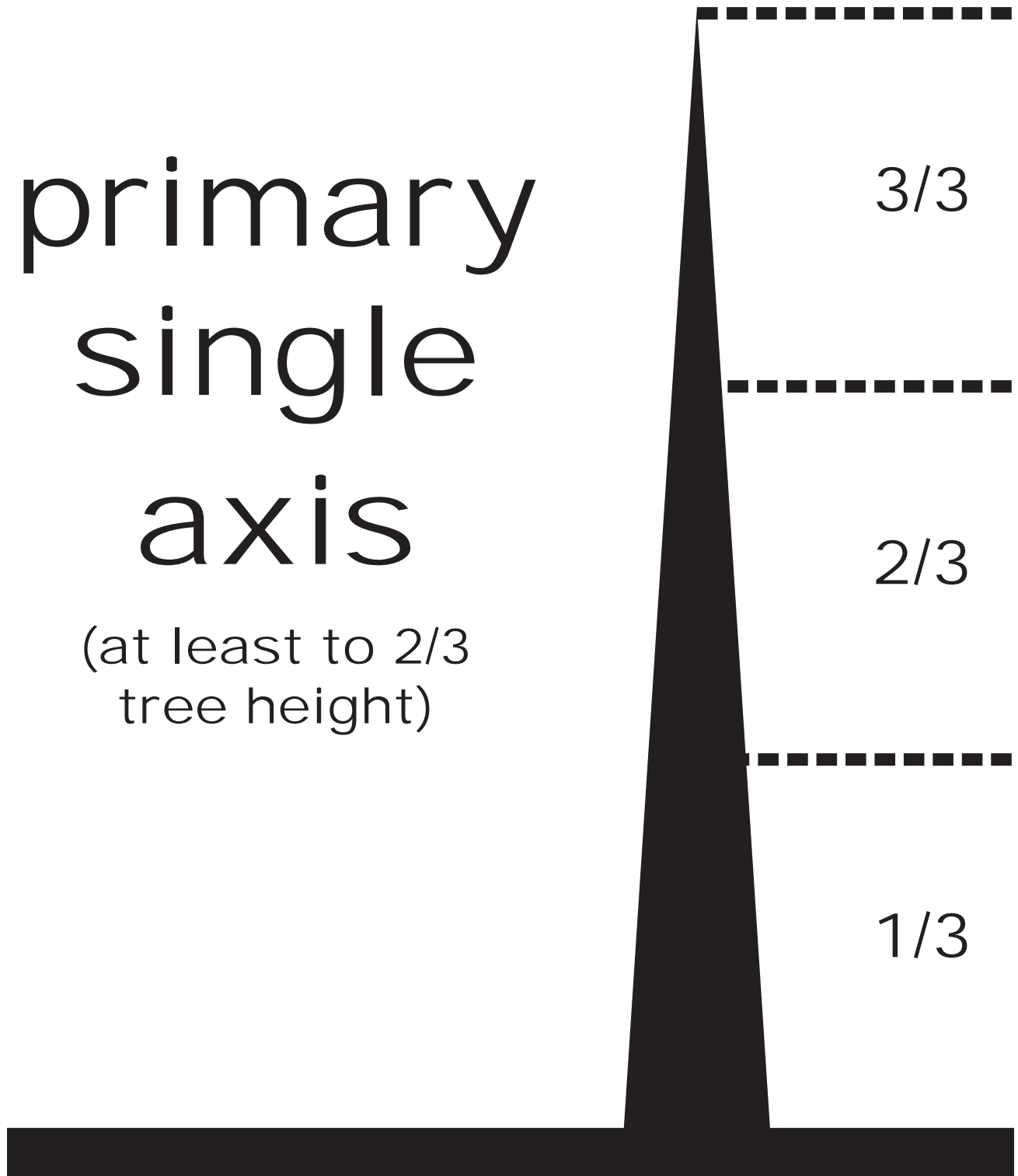
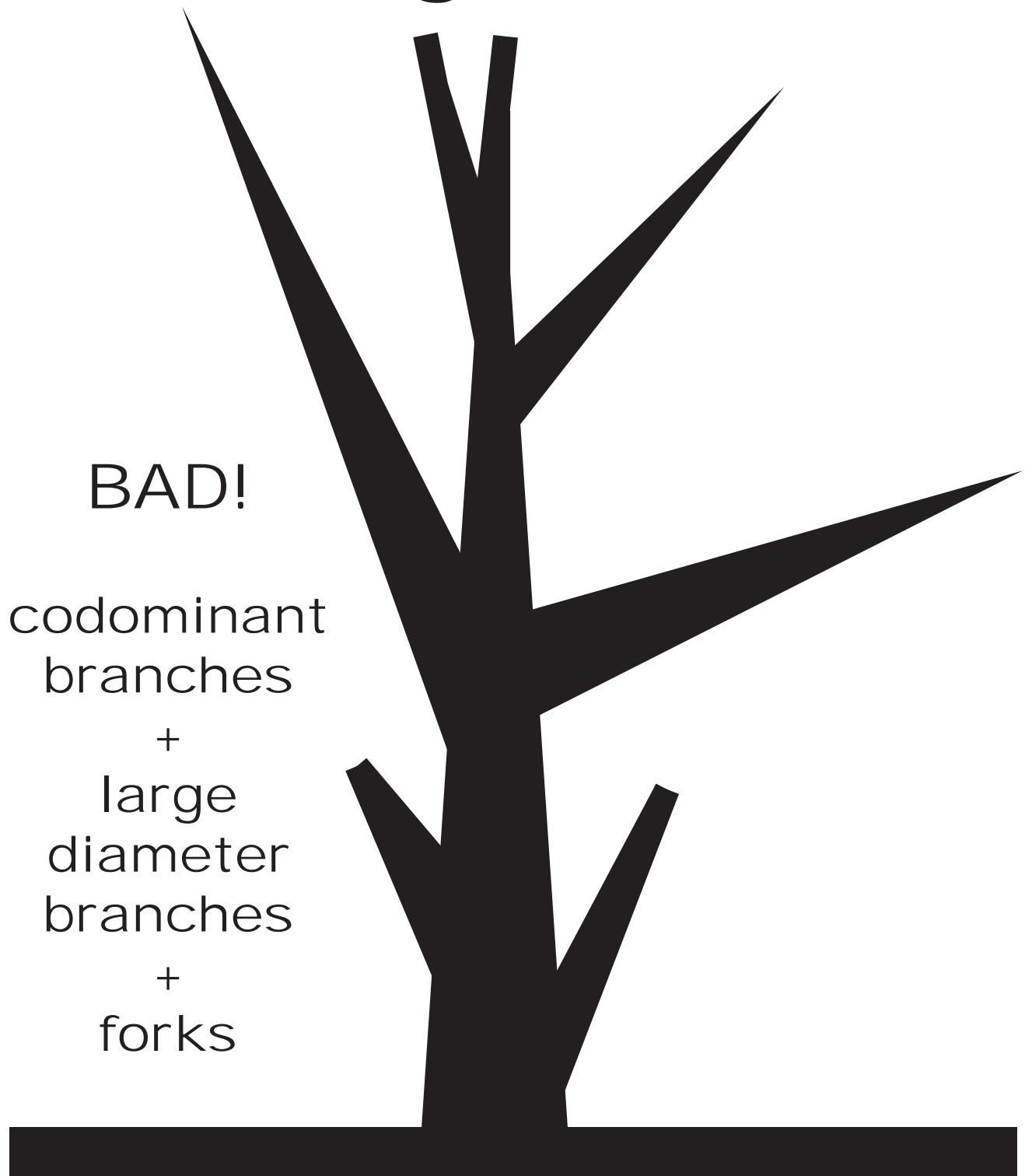

Figure 7: Diagram of a primary single axis (one dominant stem) for a tree maintained up to at least 2/3 of total tree height, if not all the way to the top.

no single leader



BAD!

codominant
branches

+

large
diameter
branches

+

forks

Figure 8: Diagram of a tree without a single axis and many large codominant branches.

single leader

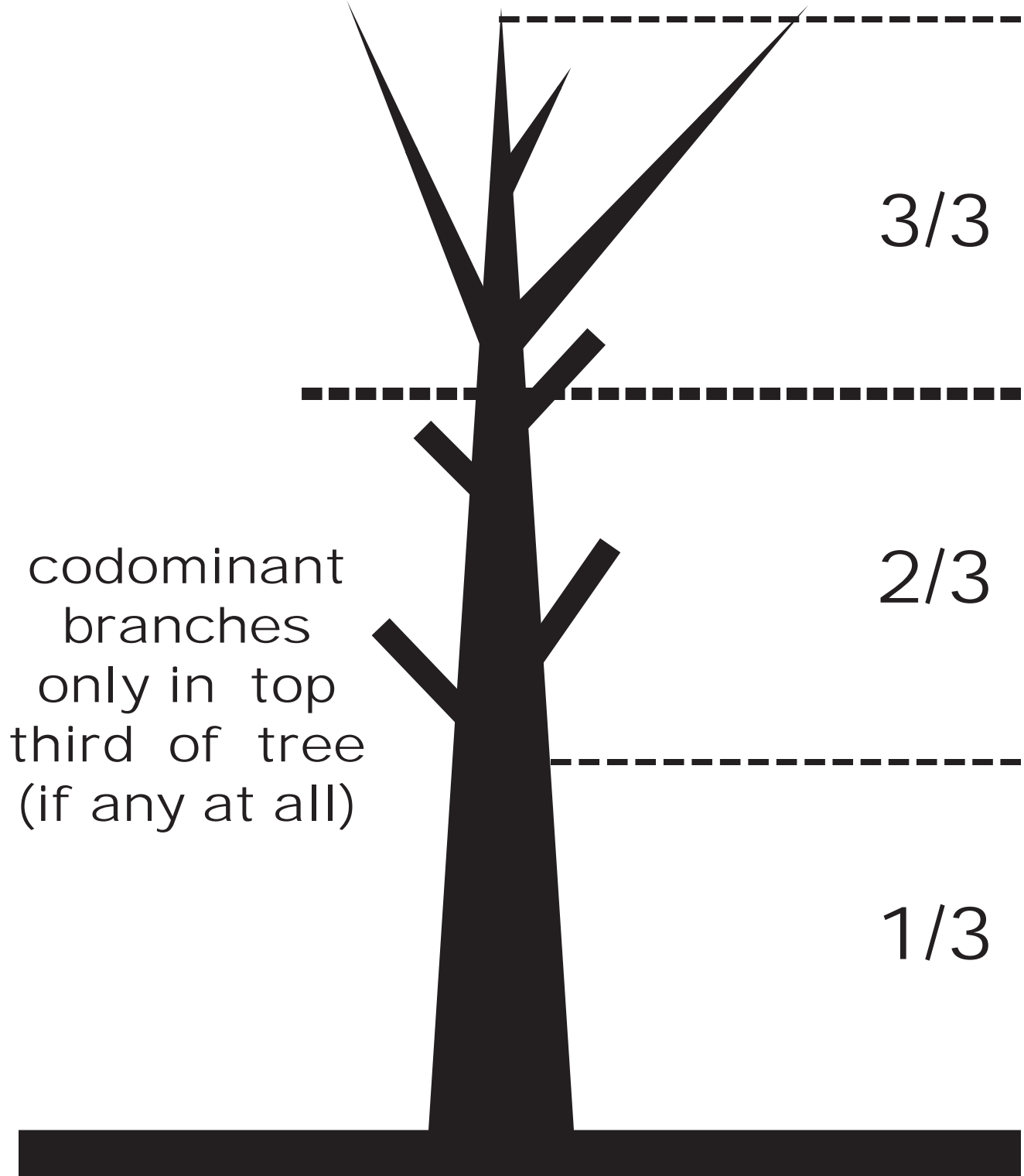

Figure 9: Diagram of a single primary axis tree with no codominant branches or forks until at least $2/3$ of the total tree height or greater.

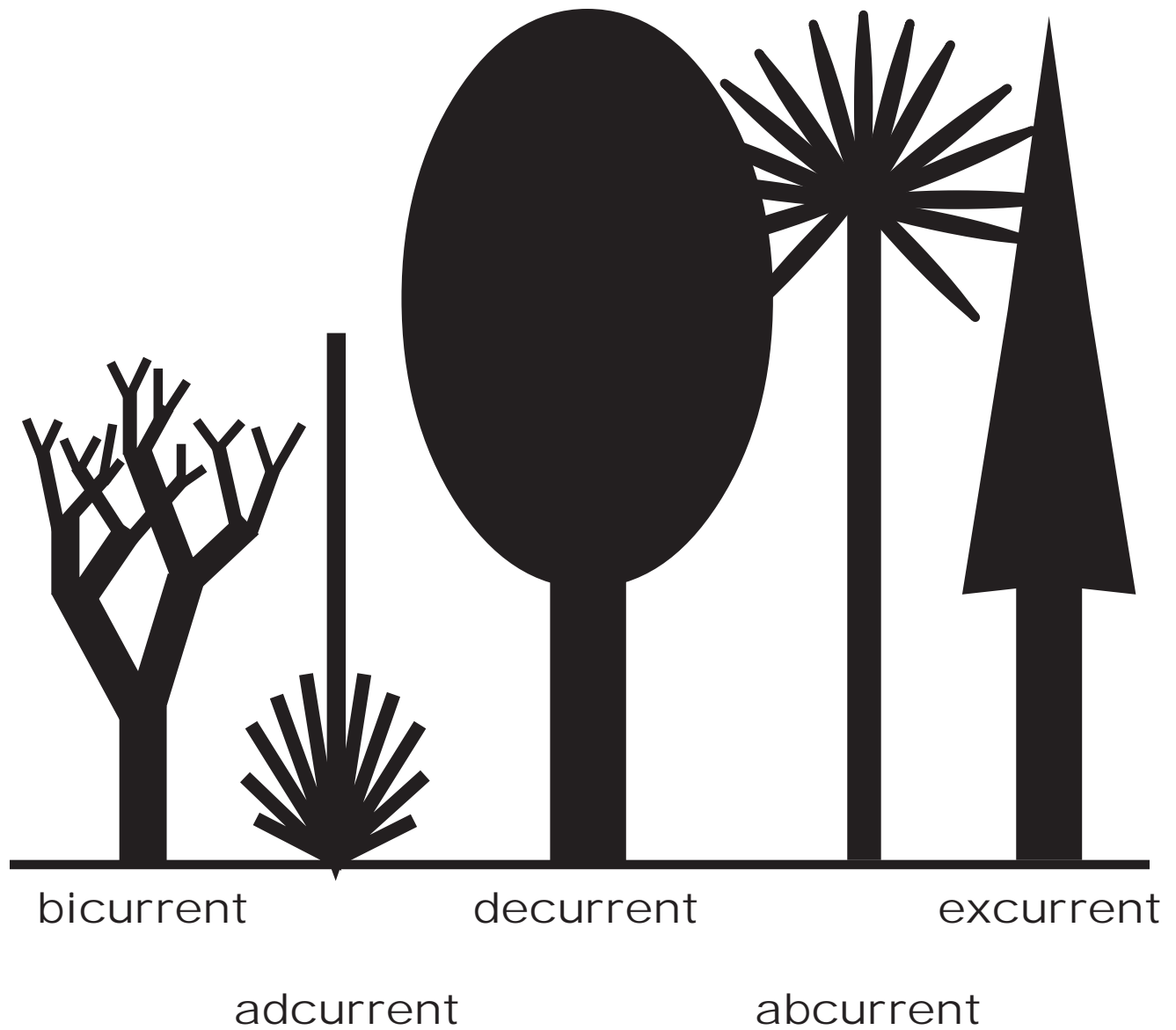

Figure 10: The five primary crown architectures found in tree-form plants. Native or genetic controlled crown shapes are highly variable.

- Bicurrent = irregular, forked, thick green stems (cactus-like);
- Adcurrent = basal buds & leaves (ground yucca types);
- Decurrent or deliquescent = many dominant branches, spreading form;
- Abcurrent = aerial terminal bud & leaves (palm-like);
- Excurrent = single dominant leader, conical form.

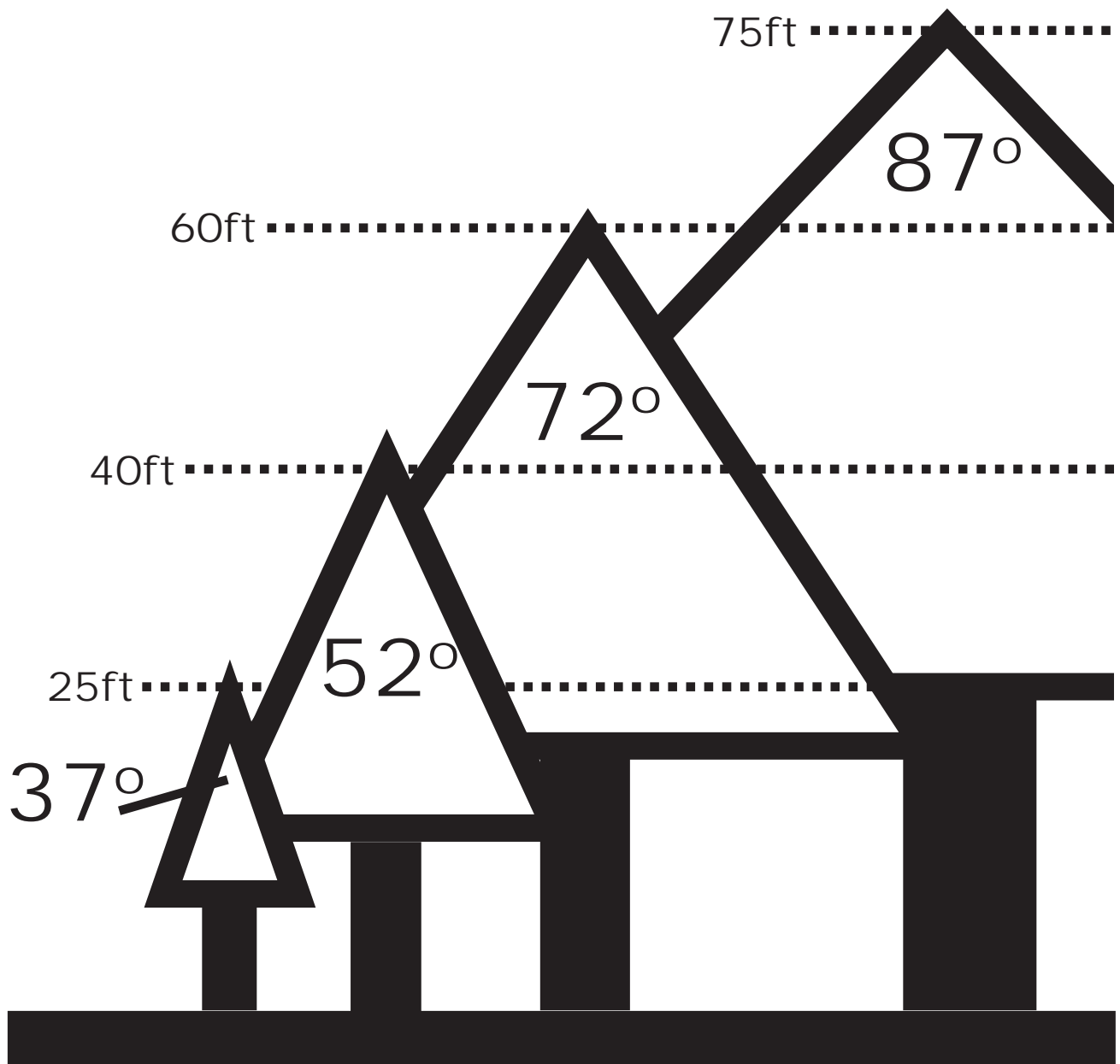

Figure 11: Diagram of four example pruning cone angles in degrees for young trees at three different heights.

total
tree
height
(feet)

$$\text{pruning cone angle in degrees} = (\text{tree height in feet} + 12)$$

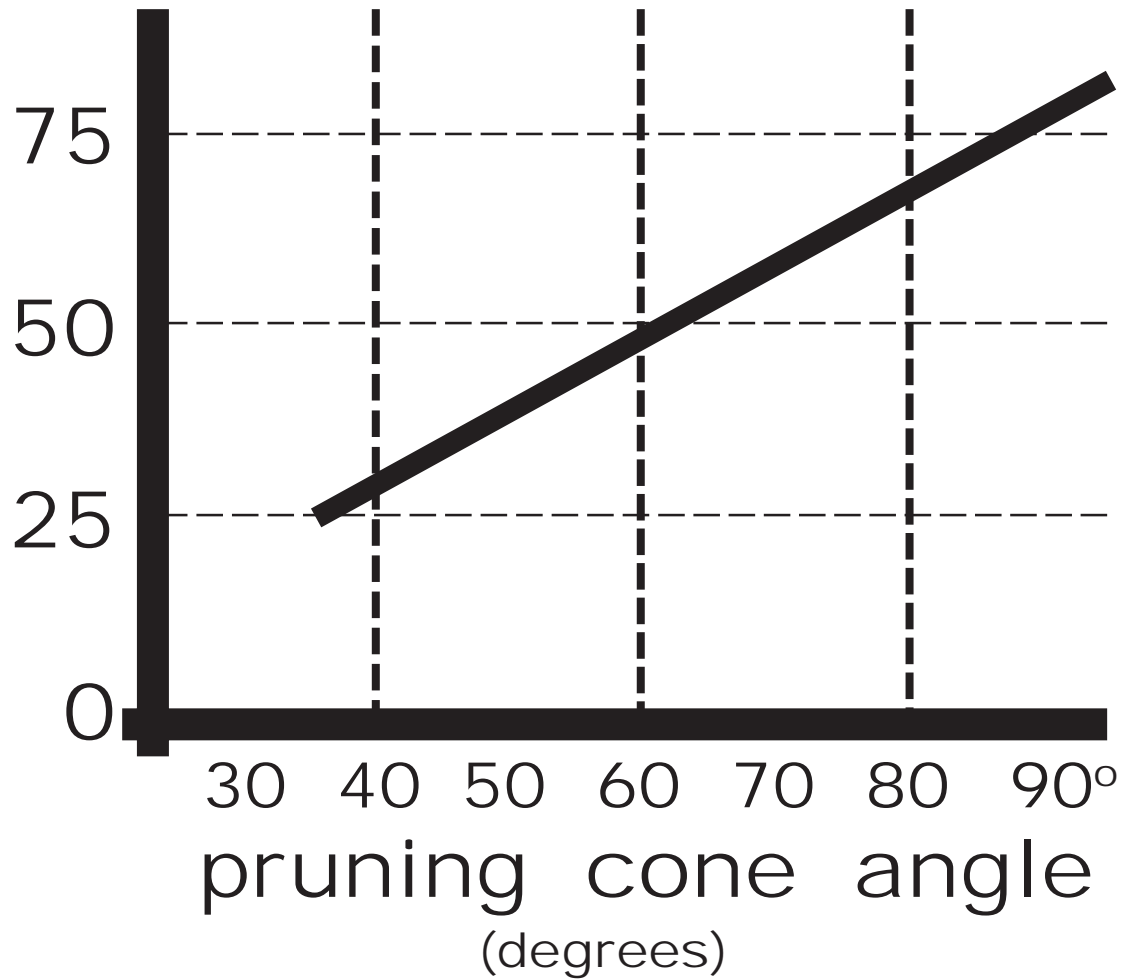

Figure 12: Graph of allowable pruning cone angles for young trees of different heights. Usually narrow pruning cone angles are used in young trees until full site clearance or form has been reached.

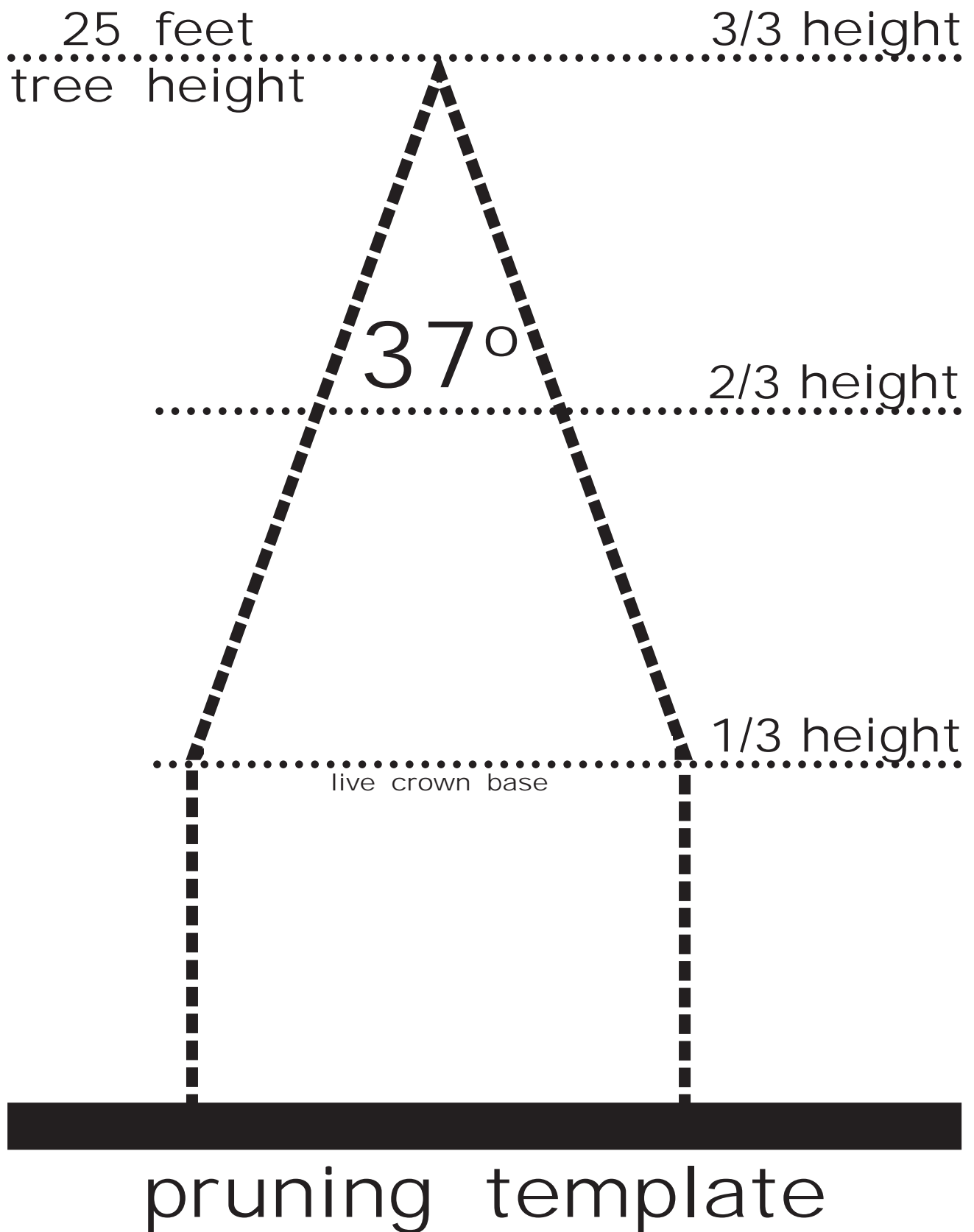

Figure 13: Outline of pruning cone limit for a tree 25 feet tall.

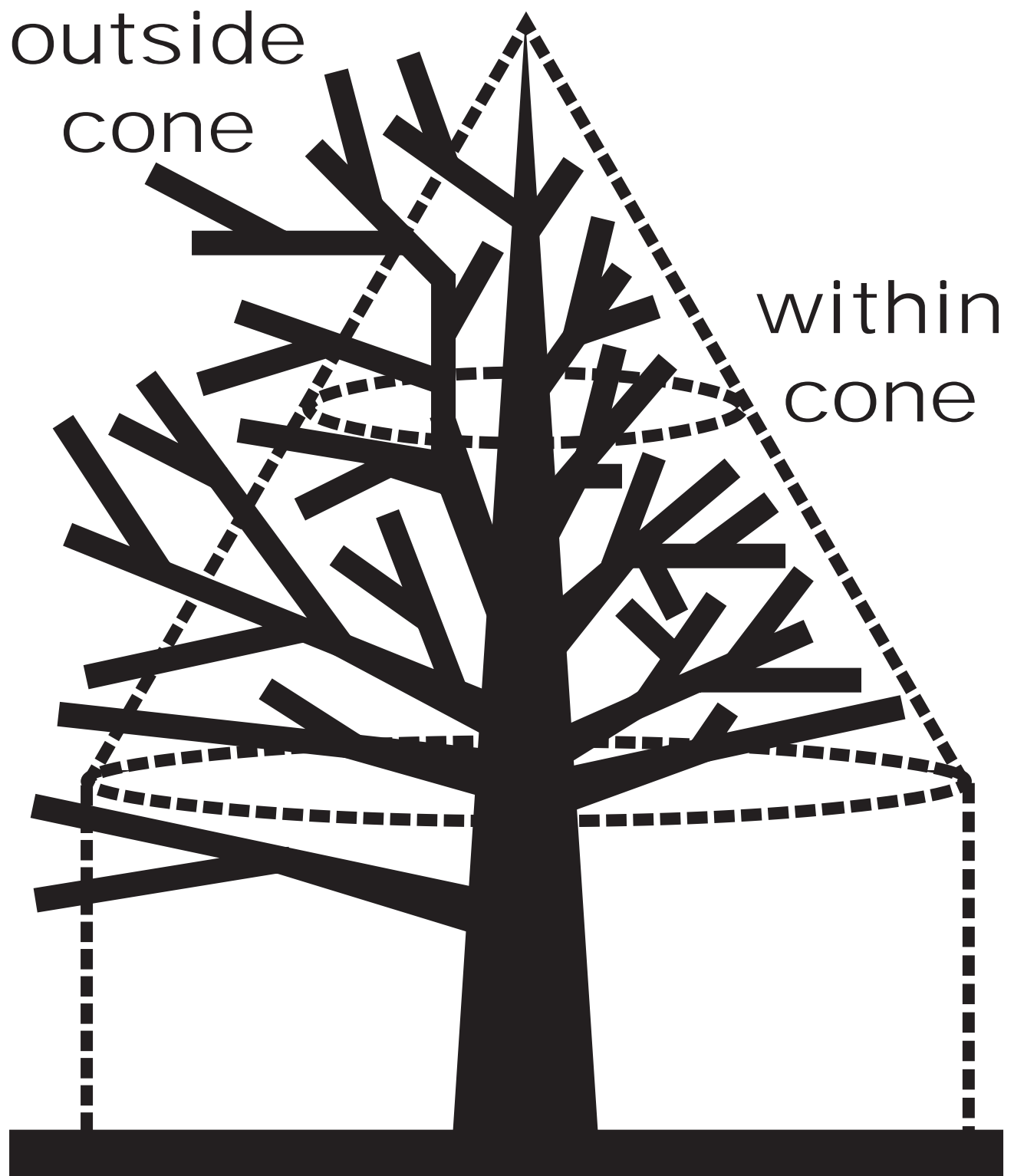

Figure 14: Pruning cone template placed over a tree. Branches outside the cone should be properly reduced back to within the cone. This is NOT a shearing, tipping, or topping guide.

Branch Length

Branch management is important in an aesthetically pleasing, healthy and structurally sound tree. Branch length control is a key feature of a pruning prescription. Biomechanically and biologically, the problems with long branches are accentuated with increasing elongation and number of nodes. When trees are well-established, young and starting to rapidly grow, control of branch length and associated diameter growth, can help funnel growth resources into the height and diameter of the main stem needed for structural integrity and biological efficiency over time, as well as reaching aesthetic criteria earlier.

Figure 15 graphically sets pruning cone limits by manipulating branch length. The pruning cone angle proportion (PCAP) is the ratio of branch length to stem height above its branch union. When preparing to reduce a branch, select a node for reducing to closer to the tree stem than the PCAP value times the height of the stem above that branch's union. As a general rule, any branch on a small to medium sized tree should not be longer in length than one-third ($PCAP = 1/3$) to one-half ($PCAP = 1/2$) the remaining stem height above that branch union.

For example from Figure 15, with a normal PCAP of $1/3$, the stem location 33 feet below tree top should support a branch no more than 11 feet in length. Always begin with the most constraining branch limits on young trees to drive proper form and prevent later prescription revision damage. Figure 16 is an example ($PCAP = 1/3$) with a 25 feet tall tree.

Gentle Aging

With tree age, allow more leniency in trees approaching their mature or site mediated height. Trees with a naturally decurrent crown form can be allowed to broaden (using increased PCAP) over time. PCAPs can be selected to increase with time, total tree height, and maturity of a tree. Table 1 presents a progressive expansion of PCAP (and associated pruning cone angle) with increasing tree height. PCAPs greater than 1.0 are not recommended for aesthetic, biological, and structural reasons.

Connections

Branches are unique features in trees. They are designed to be flexible, able to undergo lifting winds, downward forces, and a twisting figure-eight shaped sway motion in lateral winds. Branches hold leaf arrays into resource containing spaces and provide growth resources. If branches do not maintain net food production and growth regulator flow out of the branch, compartmentalization processes are initiated which limit, then seal-off resource supply lines. As branches become shaded, lose water and nitrogen supplies, or are damaged by pests or injury, branches are closed down (senescence) and die. Only a few twigs and branches are ever successful. The rest are sealed-off when young and the environment (or humans) eventually brake the branch from the tree.

A branch is connected to a stem with highly interlaced and overlapping tissues. At the base of a branch, branch tissues enter the stem and change direction to transport materials downward. The stem tissues flow around the branch base as a stream does around an island. Stem tissues provide support for the branch base, and branch base tissues are surrounded by stem tissues. Each year a new growth increment invests the branch and stem union area with expanding tissues. The branch becomes greater in diameter every year as the stem becomes bigger every year. The stem/branch confluence area becomes larger in diameter and in the volume of tissue dedicated. A stem - branch confluence allows branches to be productive while allowing the whole tree to control growth and defend itself.

Flanges

As the branch and stem tissues swirl around and down from the branch base, an enlarged area of tissue is maintained. This enlarged area of stem and branch tissue surrounds the branch base and is part

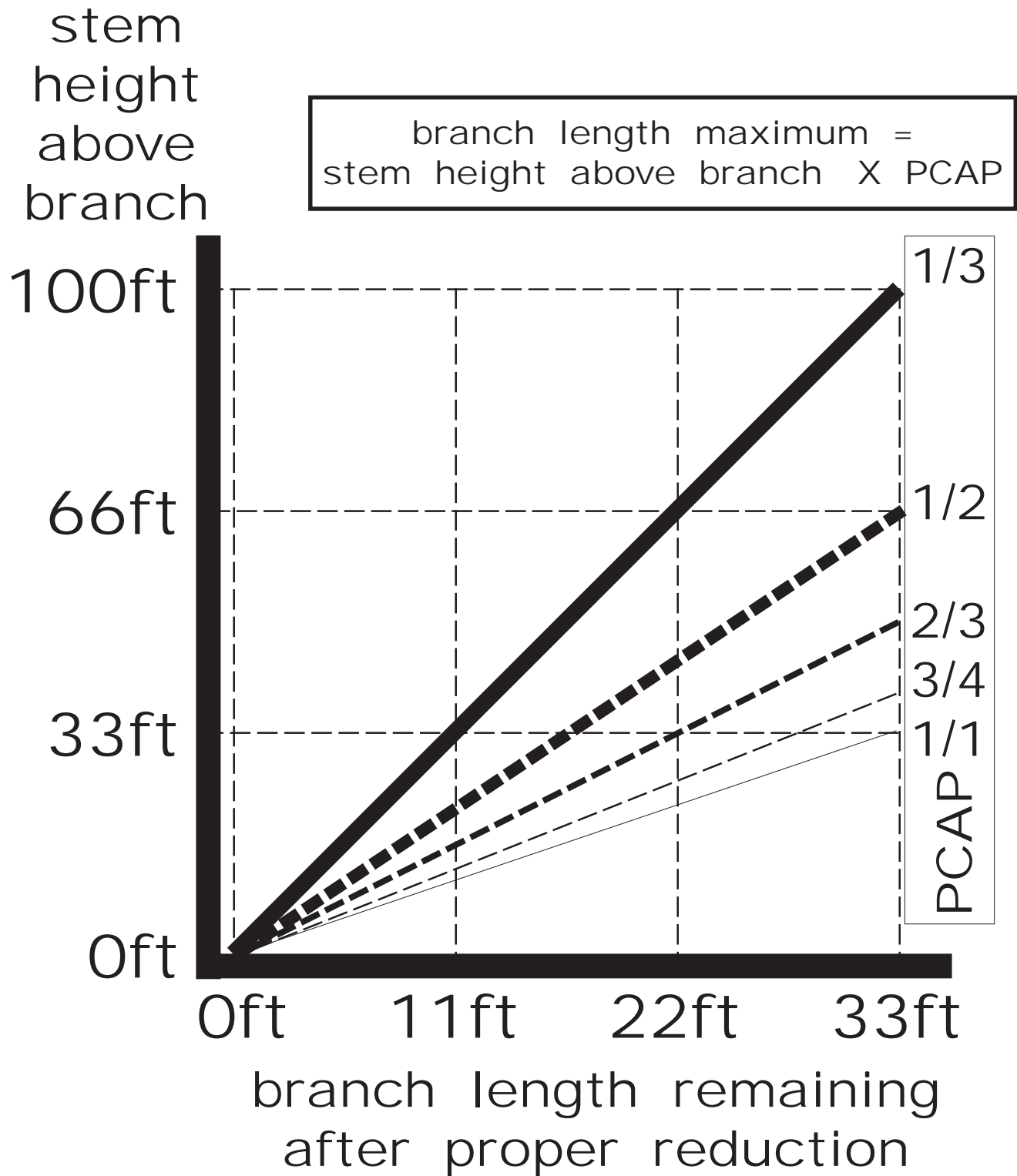

Figure 15: The maximum length of a branch compared with height of the stem above its branch union. PCAP as discussed in the text is from this graph and represents the “pruning cone angle proportion.” See Table 1.

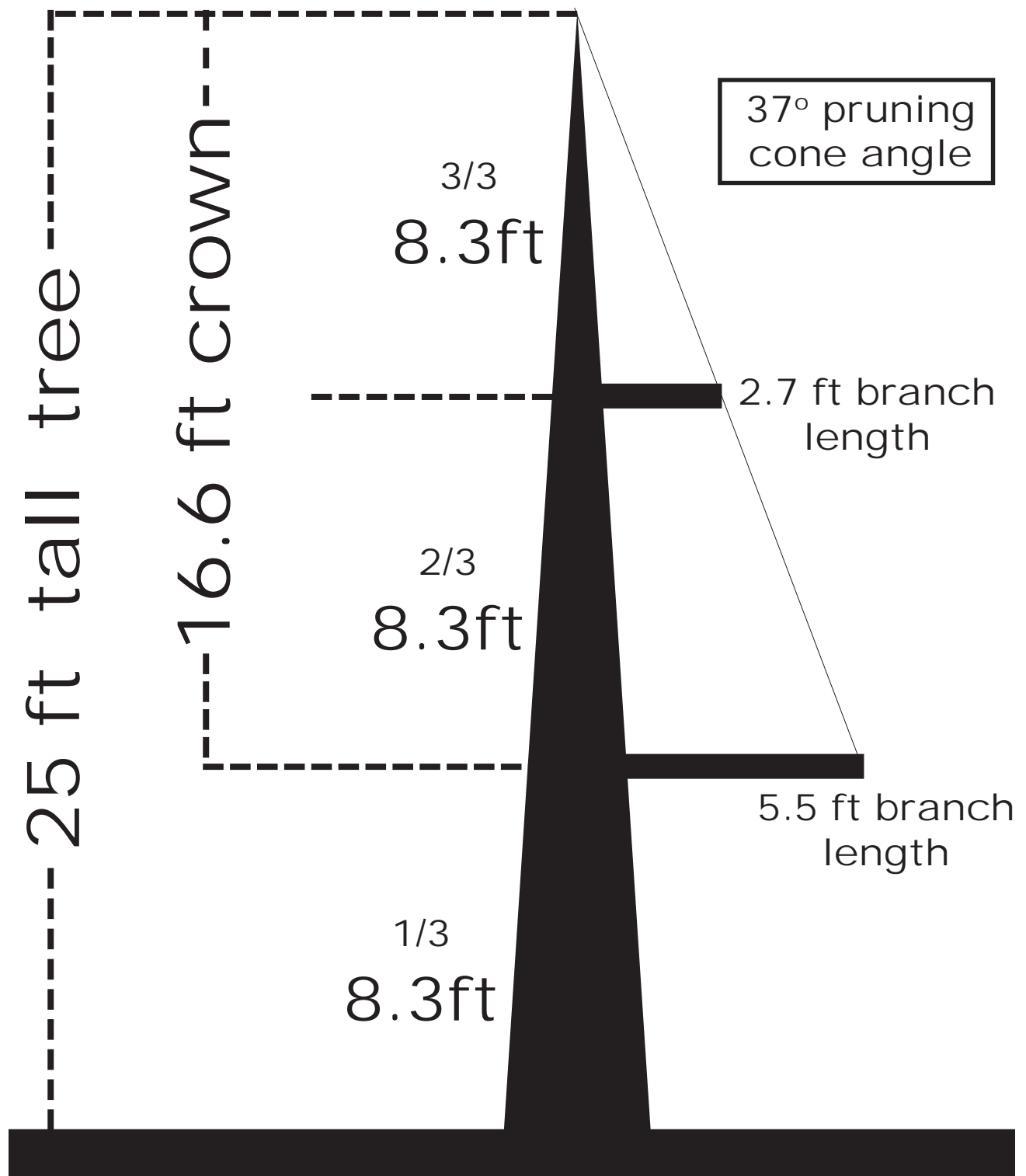

Figure 16: Example showing a side silhouette view of a small tree 25 feet tall with a live crown ratio of 66.7%. The maximum branch lengths are shown at 8.3 feet above the ground (base of the living crown) and at 16.6 feet above the ground (2/3 of tree height or 1/2 of live crown height).

Table 1: List of pruning cone angles, approximate total tree height when pruning cone angle could be applied, and approximate pruning cone angle proportion (PCAP) of [(maximum branch length) / (total tree height above branch confluence)] ratio for a tree. Conservative pruning prescriptions will use a smaller cone angle for greater heights over time. See Figure 15.

pruning cone angle	fraction form PCAP	decimal form PCAP	tree height
37°	~1/3	0.333	25ft
53°	~1/2	0.500	41ft
67°	~2/3	0.666	55ft
74°	~3/4	0.750	62ft
90°	1/1*	1.000	78ft

* do not exceed a PCAP of 1 regardless of tree height.

of the growing stem tissues of the stem-branch confluence. The tissues involved in this cooperative venture of maintaining a branch on a tree stem is called the stem flange (i.e. branch collar, stem-branch collar, stem-branch nexus, union, convergence area). Figure 17. On the underside of a branch, as branch tissues enter the stem area and turn downward, the branch base noticeably increases in diameter beyond branch diameter. The tissue swelling on the branch underside is part of combined supporting stem and branch tissues. The stem flange may be visible for some distance on the branch underside.

Because branches get larger in diameter every year, and the stem gets bigger in diameter every year, there is an area on the very top of the stem-branch confluence where living tissue is close to the surface and bark is being generated quickly to cover the site. The growth pressures in this area caused by the branch and stem tissue confluence and associated localized bark growth, causes a visible disruption of internode stem and bark patterns.

Chines

A bark chine is initially formed in the top confluence of stem and branch, and represents a sensitive and damage prone point in a tree. Figure 18 demonstrates over time how localized bark growth, underlain by multiple tissue interleaving and changes in direction, expands over time. This topmost area of the stem - branch confluence is the bark chine or bark ridge (i.e. branch bark ridge (BBR), stem bark ridge, branch union bark ridge). As both stem and branch grow, like in an expanding balloon, adjacent points on the circumference grow apart. A branch chine can be seen behind every branch on the main stem demonstrating limited branch history by its length and angle.

The chine, or localized bark growth area, is usually rapidly growing covering new stem and branch tissues pushing against each other at the top of the stem-branch confluence. The bark cambium is generated rapidly to prevent being overgrown by phloem generated by the vascular cambium. Sometimes, due to growth regulator transport problems and physical constraints of a narrow and confining confluence area, the bark cambium may become folded in upon itself, generating bark to bark contact inside the stem-branch confluence area. Figure 19. This bark growth form fails to produce a normal outward growing bark chine and instead leaves a visible indentation, fold, or rimple. This process of forming a folded rimple yields bark inside the stem-branch confluence area called “included bark”. Included bark weakens the stem flange area. These types of bark ripples are telltale signs of structural problems at the base of a branch, and are usually pruned away in young trees.

Nodes

Trees are modular and segmented organisms. They grow discrete parts and pruning removes these parts. One means to think about trees is to liken their crown structure to an antique children toy generically called “tinker toys”. These construction toys were made of round pieces with many insertion holes and of various lengths of straight sticks. With just these two components a child could construct many three-dimensional shapes. The rules were simple for construction, a stick could not be held by a stick and a round block could not hold another round block, but alternating these components allowed for construction. The round blocks are multidirectional nodes and the straight sticks separate the nodes by some distance.

In trees, everywhere a leaf, bud, or twig emerge is a node -- a place where tissues have been redirected to connect and support tissue growth. In between nodes are straight twig, branch and stem segments -- called internodes. Figure 20. On any small branch there will be lateral branches, lateral buds, new sprouts, and leaves. Each of these organs arise from a node and are separated by internodes. Nodes are areas in trees where many ray cells and transport tissues are concentrated to support and supply tissues growing in new directions. Nodes are centers for strong defensive reactions, closing off more distant tissues if they are not productive. Internodes have limited defensive capabilities, especially along the longitudinal axis. Damaged internodes usually are sealed off at the nearest stem side node.

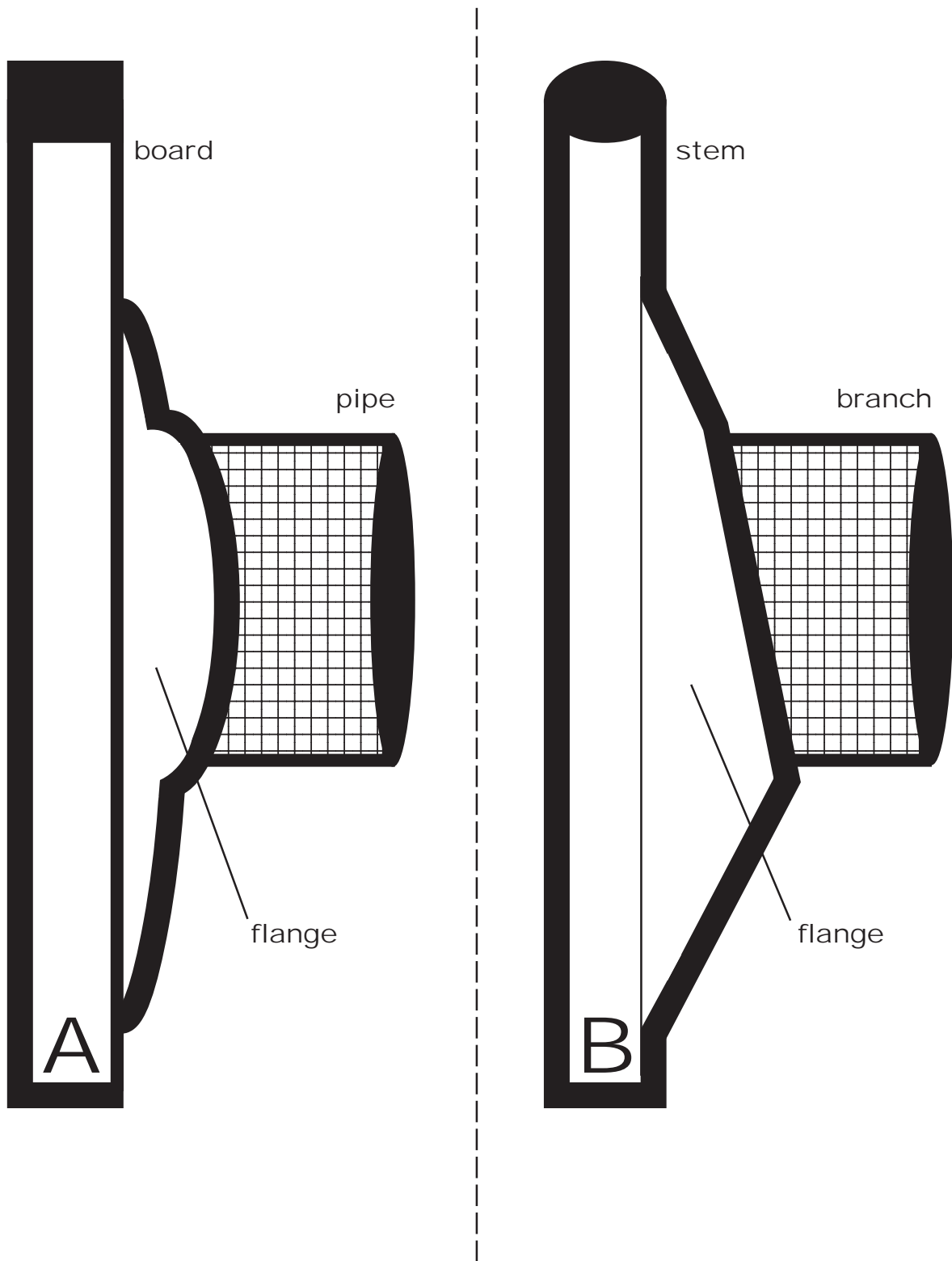

Figure 17: Descriptive model of a pipe held onto a board with a flange (A), and a branch held onto a stem with a combined tissue area acting as a flange (B).

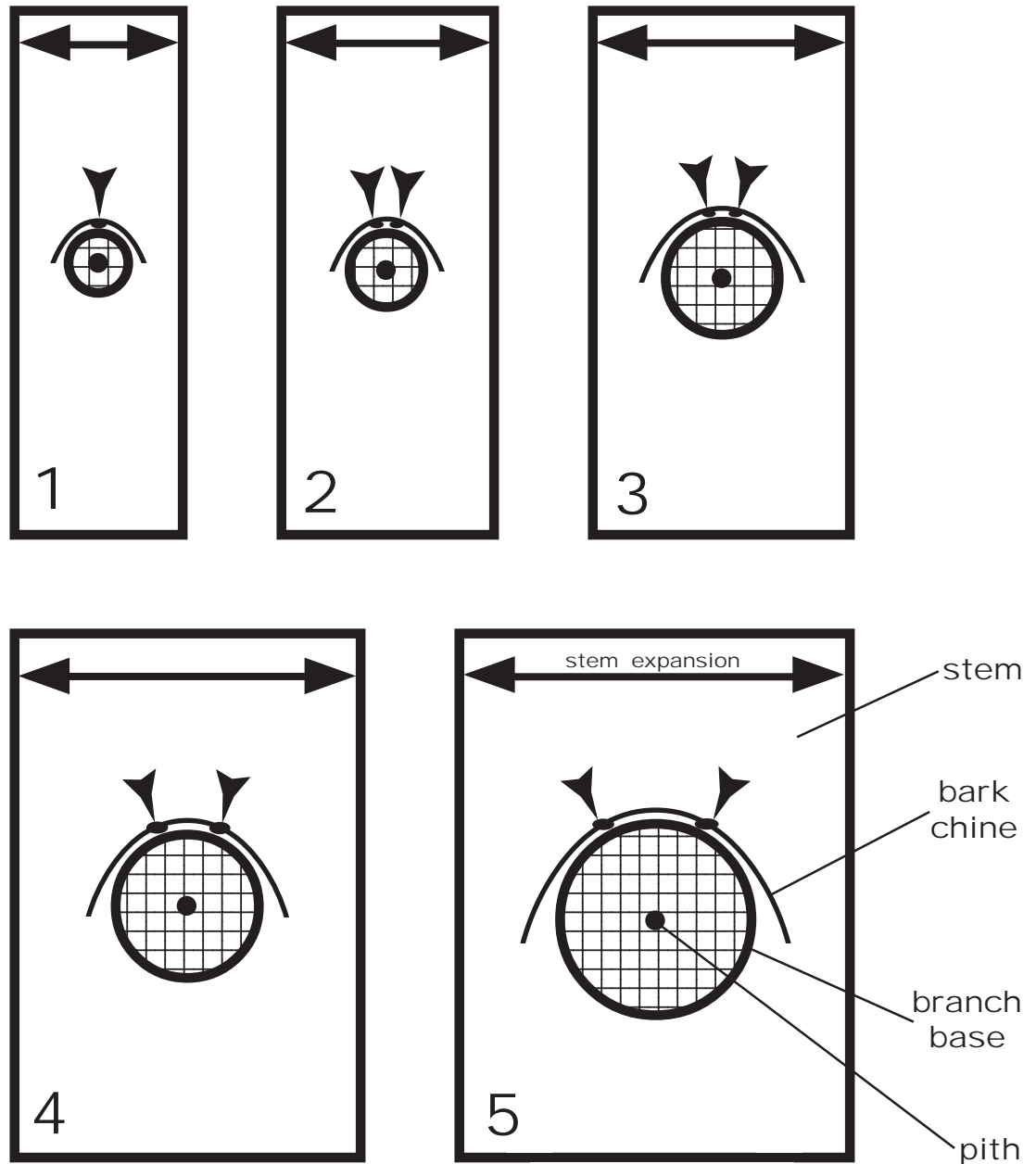

Figure 18: Diagram representing circular cross-sectional areas (shaded) of a branch base at the confluence with the stem over time (#1 is youngest / smallest size). A bark chine is initiated at the topmost position over the branch (#1 -- note arrow point ▼) where tissues of stem and branch grow against each other. As both stem and branch grow in diameter (#2 - #5), points on the bark chine (arrows) continue to show greater separation.

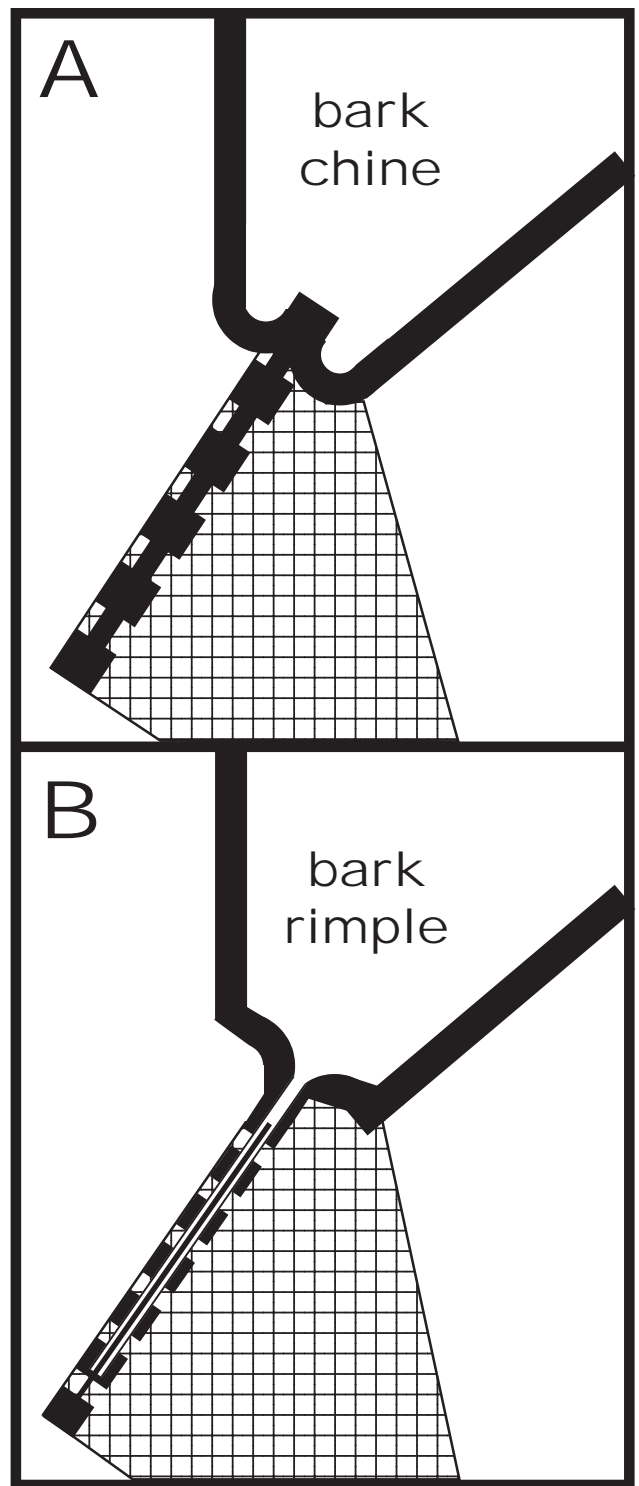
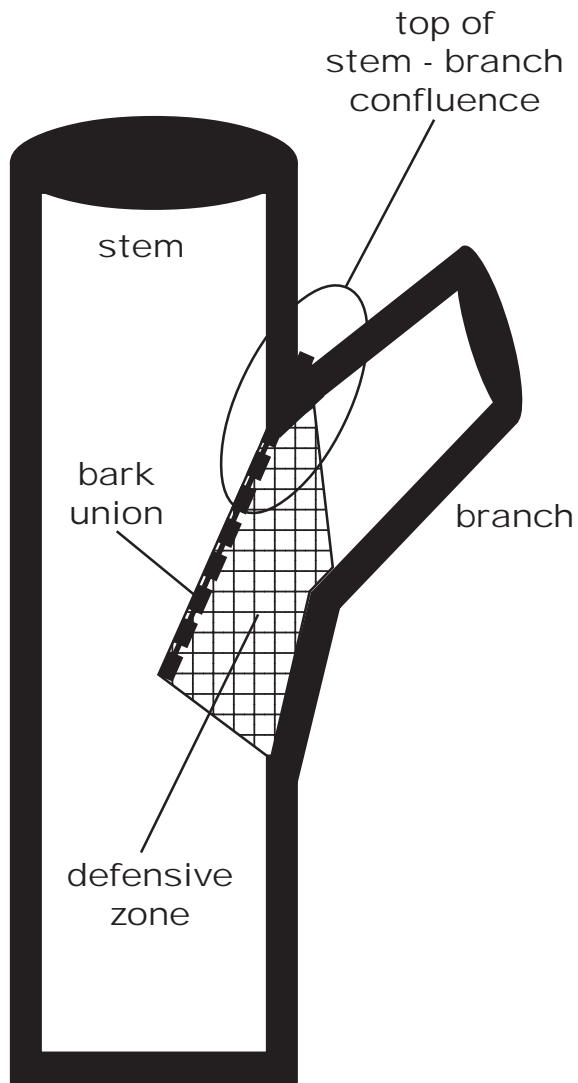

Figure 19: Diagram showing close-up view of the top of a stem-branch confluence area and the appearance of two generic types of bark unions: A) a chine (ridge or crest); B) a rimple (fold or wrinkle). The rimple union can contain bark folded inside.

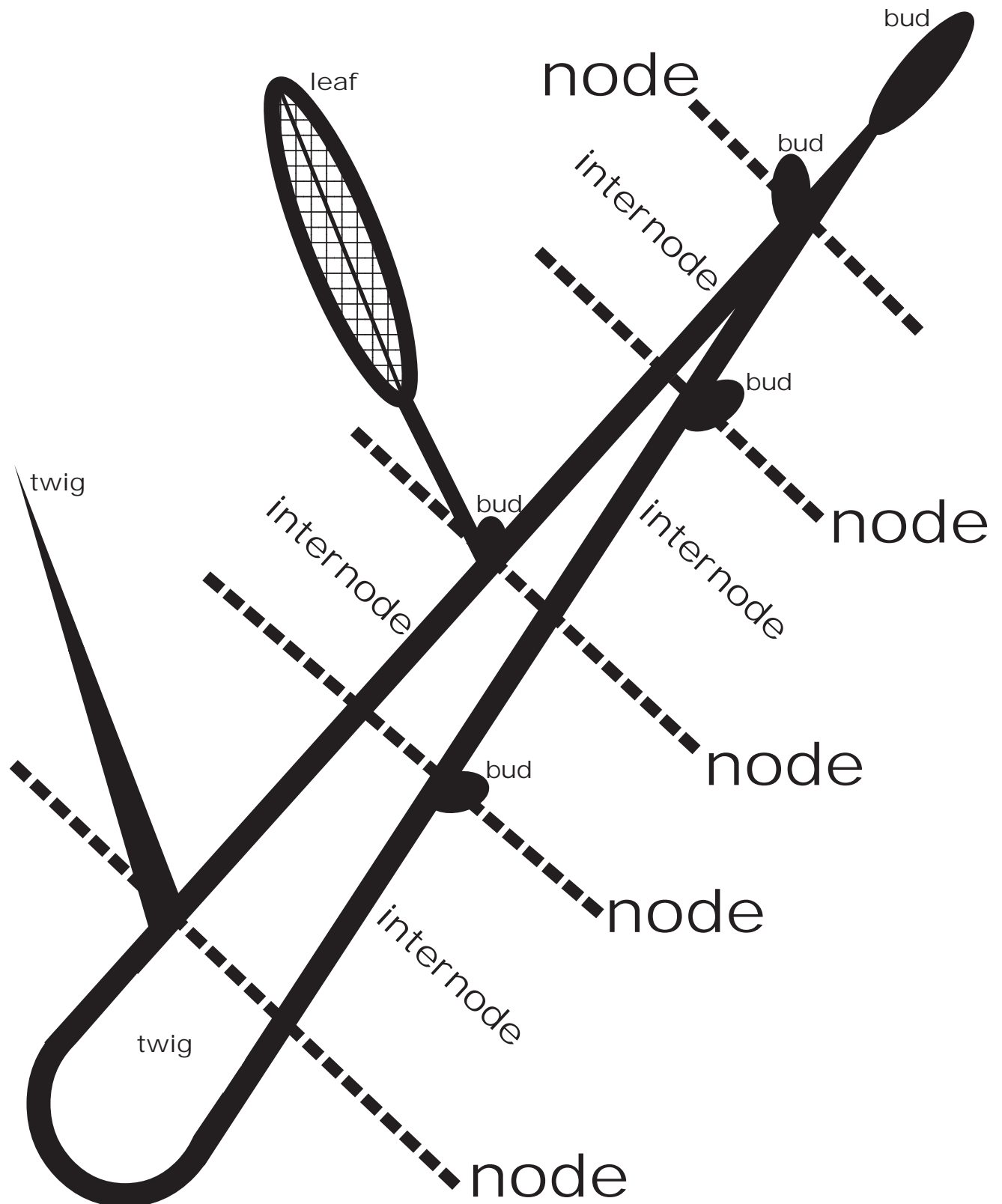

Figure 20: Diagram of a twig with five nodes (dotted lines across twig) and four internode areas identified along a short length. Internodes are spaces or twig lengths between nodes. Nodes are from where buds, leaves, sprouts, twigs, or branches grow.

Defense

One component of pruning which must always be kept in mind is the capability of living tissues remaining after a cut to defend the tree. A strong compartmentalization response is essential to prevent compounding and collateral injuries at the pruning wound site. Key to understanding a tree's defensive response is the conical shaped defensive zone behind the pruning wound face comprised of interlaced stem and old branch tissues. This defensive zone minimizes loss of valuable electrons from within living tissues, minimizes water loss, and resists attack from other organisms seeking entry into the tree. See Figure 21 for a diagram of where a defensive zone is developed behind a pruning wound for a small diameter branch. Remember these two-dimensional diagrams are representing three dimensional, conically shaped volumes.

Forked stems (multiple upright stems) and codominant branches (branches growing from other branches or stems which have nearly the same diameter at the branch union) have defensive architecture compromised by rapid relative growth rates and physical diameters of their connections. Forks should be removed early in tree life. Figure 22. Codominant branches do not effectively develop defensive zones at their bases. Pruning of a codominant branch leaves a tree in a poor defensive position to deal with wounding. It is clear that branches should not be allowed to reach basal diameters approaching the diameter of the stem to where they are attached.

Diameter Limits

Figure 23 provides a graphical definition of branch diameter limits for pruning. Figure 24 is a diagram showing the largest size of branch to be pruned is less than one-third to one-half stem diameter at the branch union. Remove branches as they approach or exceed this diameter ratio. Figure 25. Delaying pruning of large diameter branches (codominant branches) can lead to many problems for a tree both in the short and long run. Early prevention of codominant branches is essential.

On branches which have well established stem flanges, and are $1/3$ to $1/2$ the diameter of the stem where they are attached, a traditional proper pruning cut is essential. Depending upon the size and weight of the branch, either a one-cut or three-cut pruning process can be used. A three cut method, sometimes called the Davey, Shigo, or target pruning cut, identifies specific structural targets in the stem flange area.

Collared

Note the final pruning cut is always immediately outside the stem flange. The stem flange is blended tissues of stem and branch growing together at the branch base. The stem flange helps stitch the branch onto the stem. The outside edge of the stem flange can be identified both on the top and bottom of the branch just as the branch enters the stem. The bottom branch-side edge of the stem flange can be seen as a slight swelling of tissues on the branch underside just before it enters the stem. Never nick or cut into this area. Figure 26.

The upper branch-side edge of the stem flange can be seen outside the bark chine just before branch enters stem. The stem flange begins at a point where the upper side of the branch base starts to swell or curve up forming the bark chine. Figure 27 shows a diagram identifying pruning targets on a stem - branch confluence. Never cut on the stem side of the bark chine, on the bark chine, or the branch side swelling which pushes up into the bark chine. These areas are composed of both branch and stem tissue. Never nick from either side the bark chine. Pruning should only remove branch tissue, not expose and damage stem tissues. In addition, do not injure the stem with the back of a saw.

Cut'em

Once branch pruning targets are identified, they are used to set the boundary and saw kerf line of the final pruning cut. Figure 28 demonstrates target pruning for generic angiosperms and Figure 29 demon-

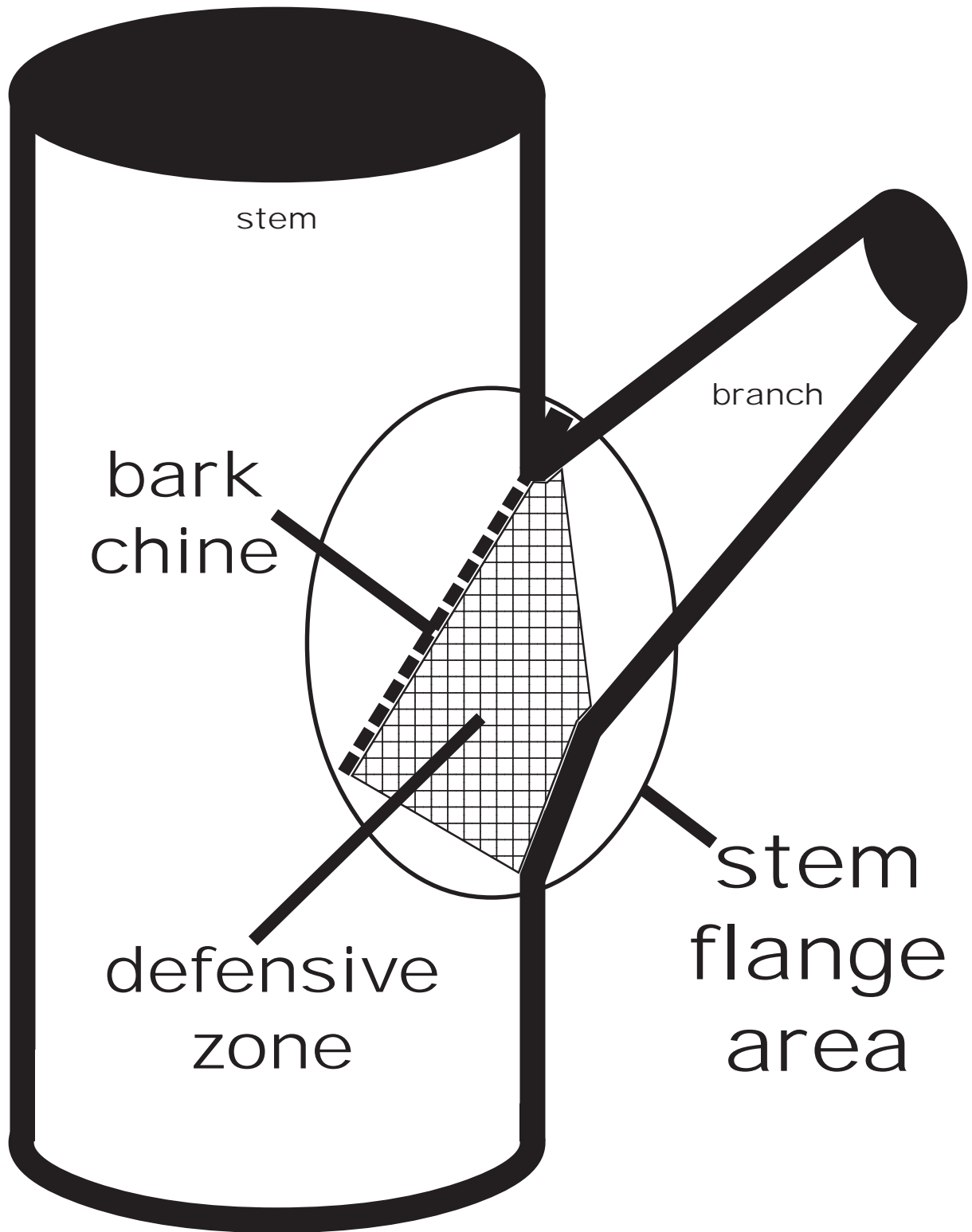

Figure 21: Stem flange or stem-branch confluence area showing the bark chine (bark ridge) and defensive zone (shaded) on a normally proportioned branch.

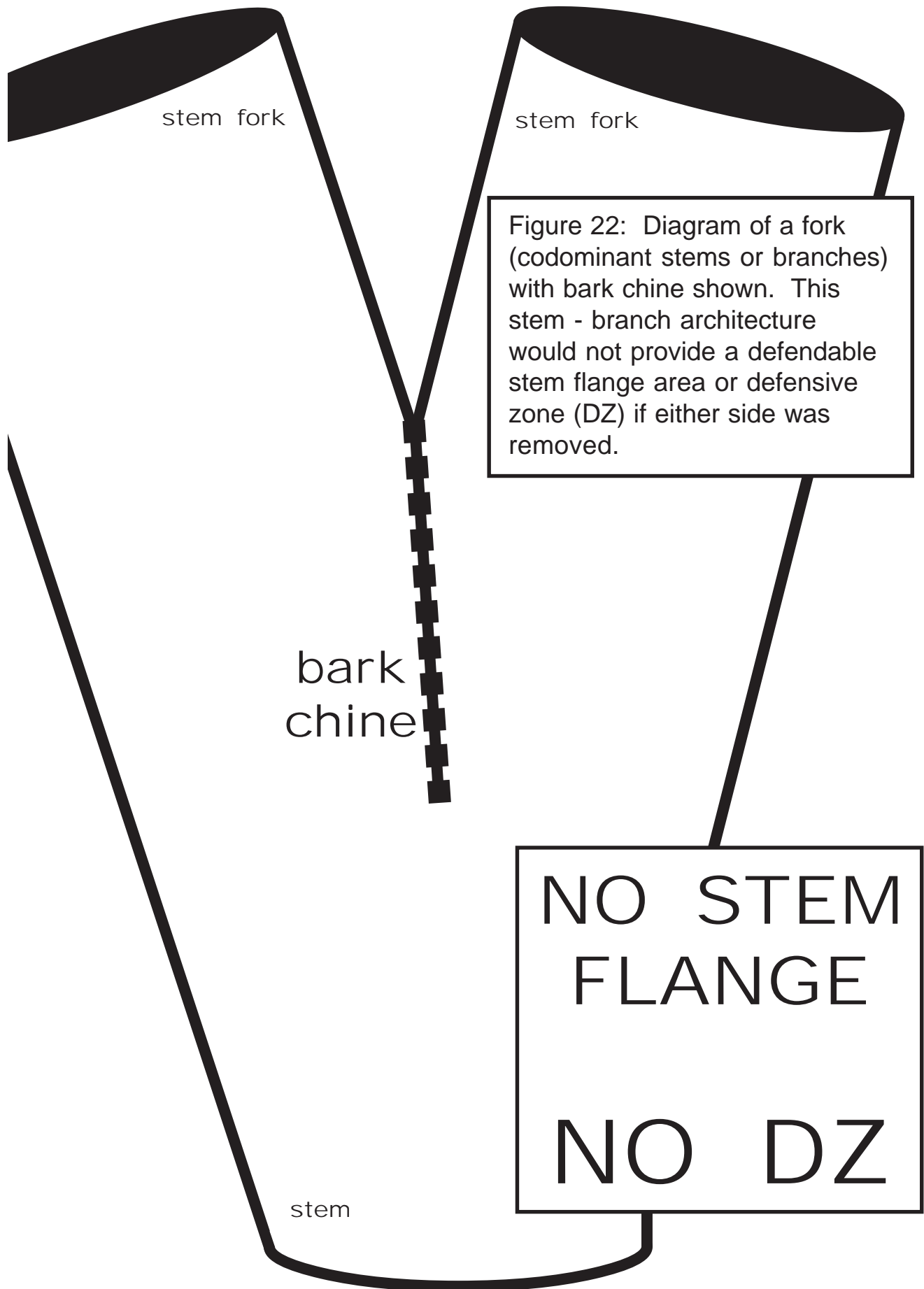

Figure 22: Diagram of a fork (codominant stems or branches) with bark chine shown. This stem - branch architecture would not provide a defensible stem flange area or defensive zone (DZ) if either side was removed.

NO STEM
FLANGE
NO DZ

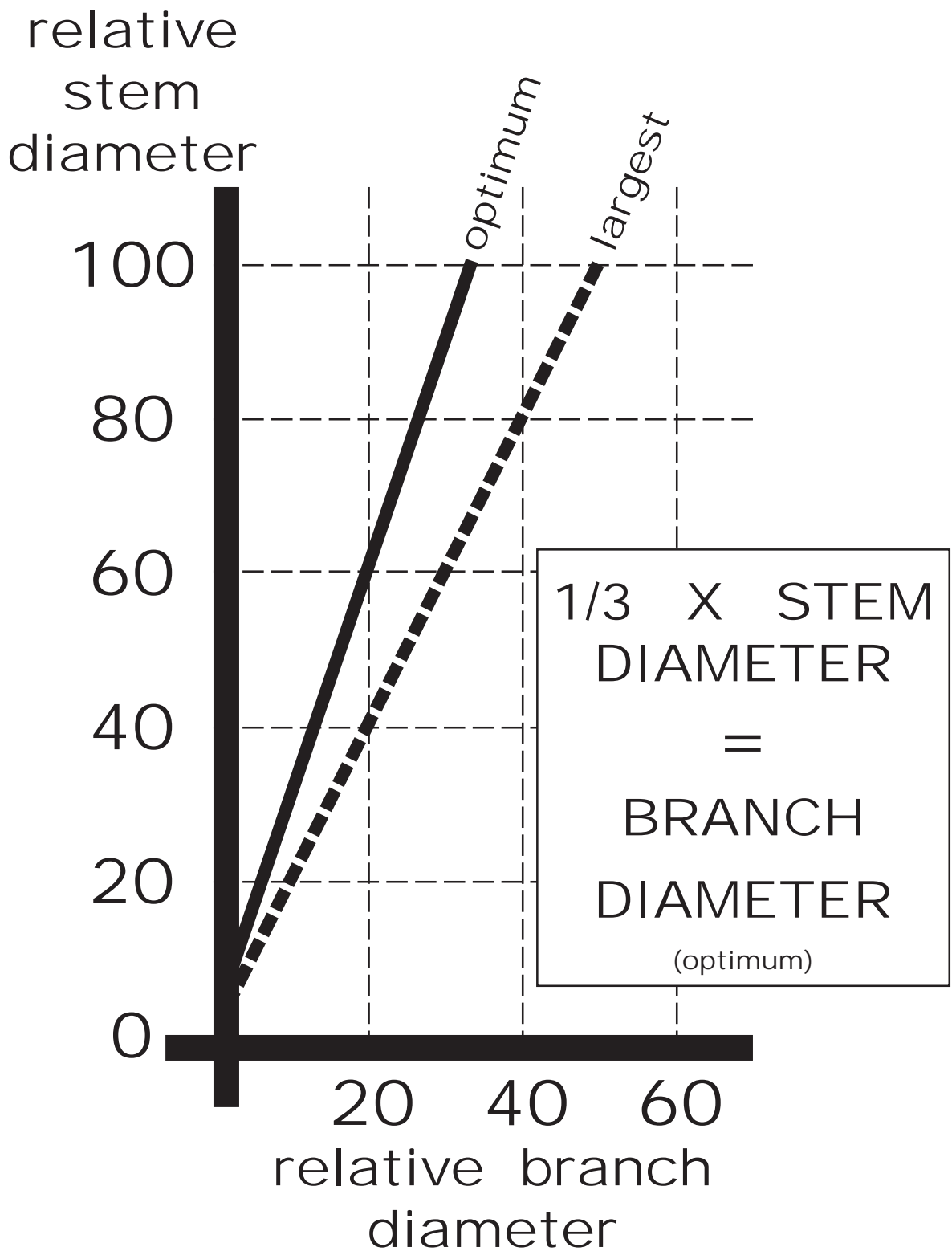

Figure 23: Relative stem diameter versus largest branch diameter at the stem - branch confluence for optimum form [branch diameter 1/3 stem diameter]. Largest acceptable branch diameter is 1/2 stem diameter at stem - branch confluence.

LARGEST BRANCHES TO LEAVE

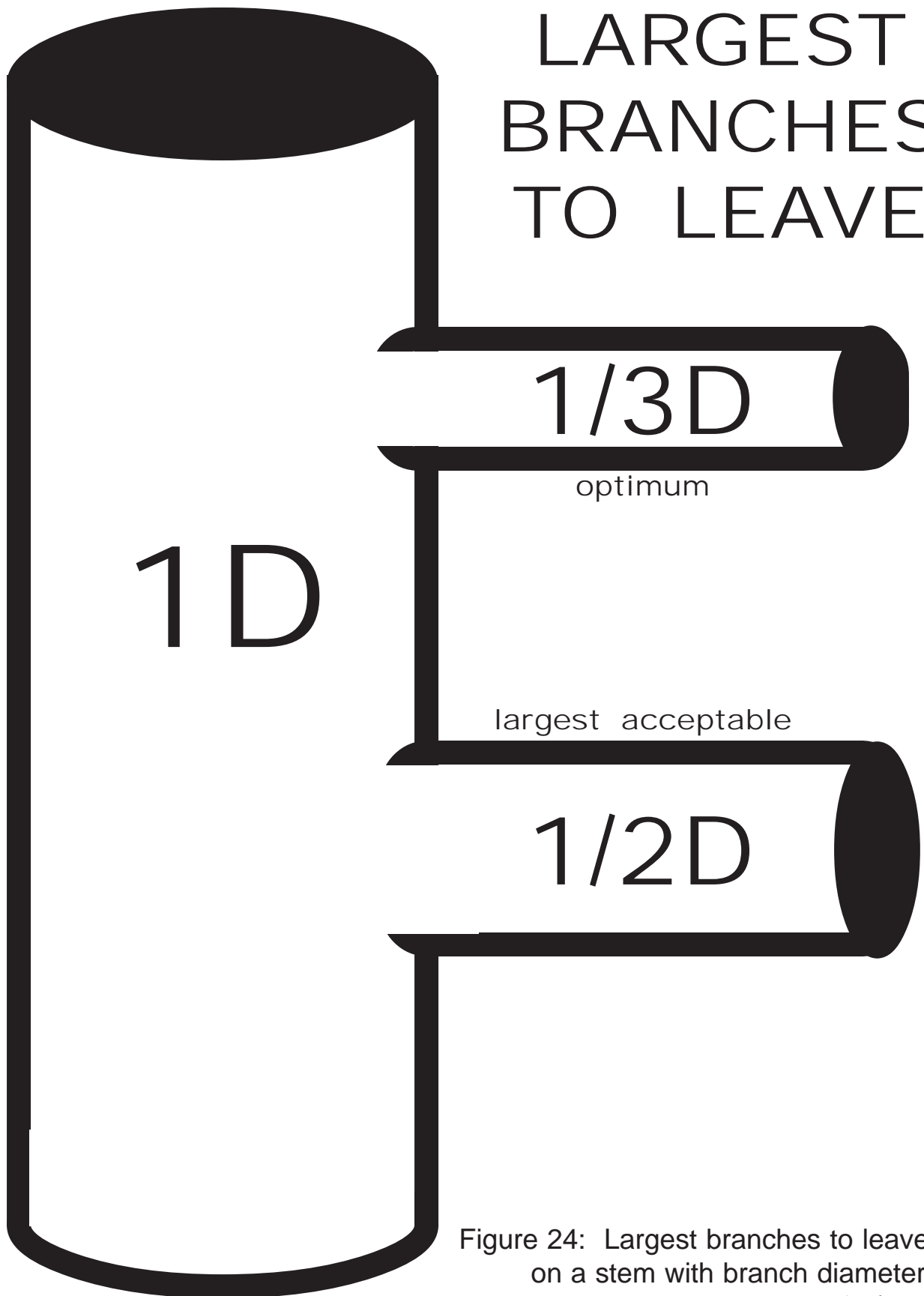
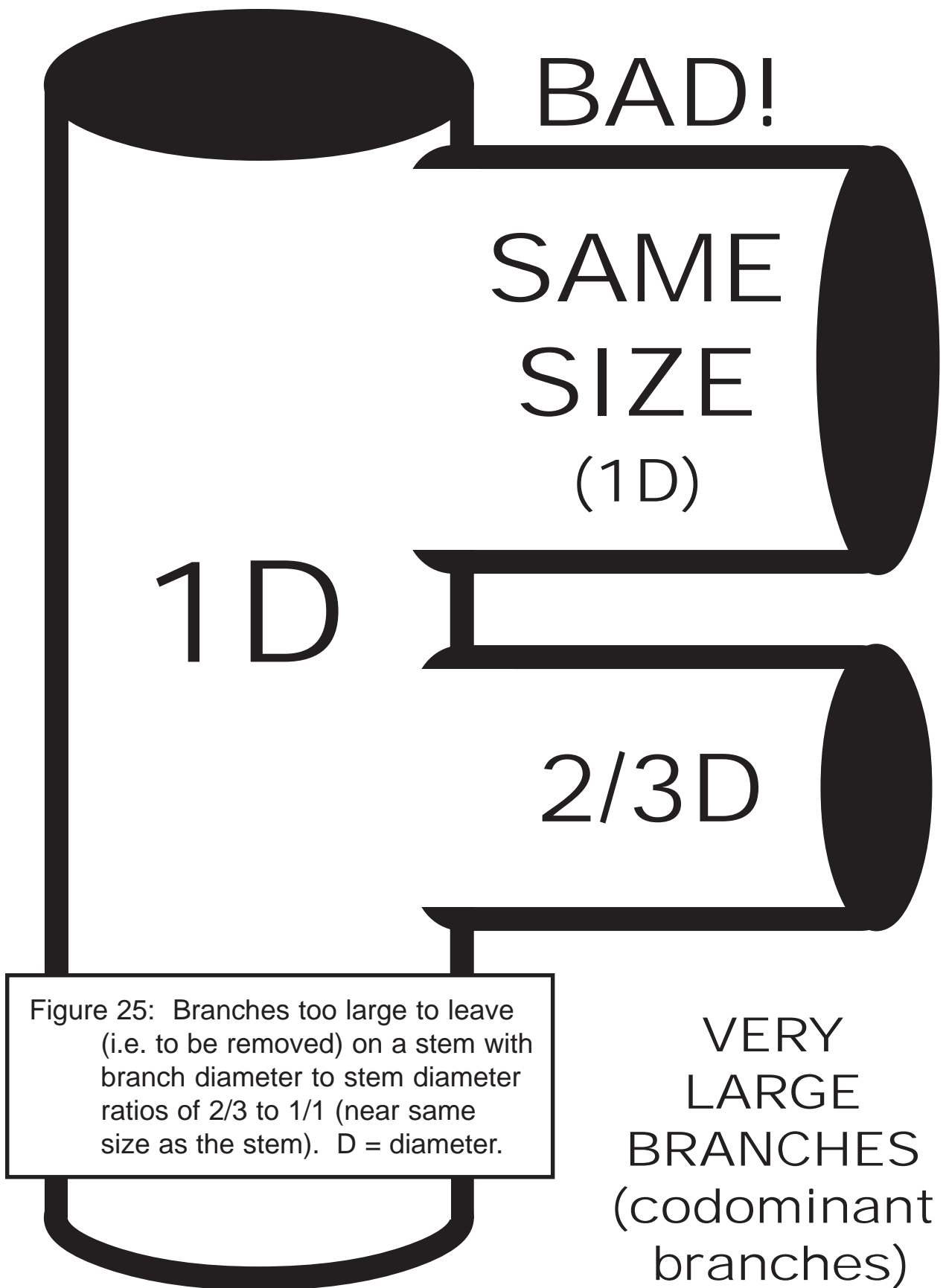

Figure 24: Largest branches to leave on a stem with branch diameter to stem diameter ratios of $1/3$ to $1/2$. D = diameter.



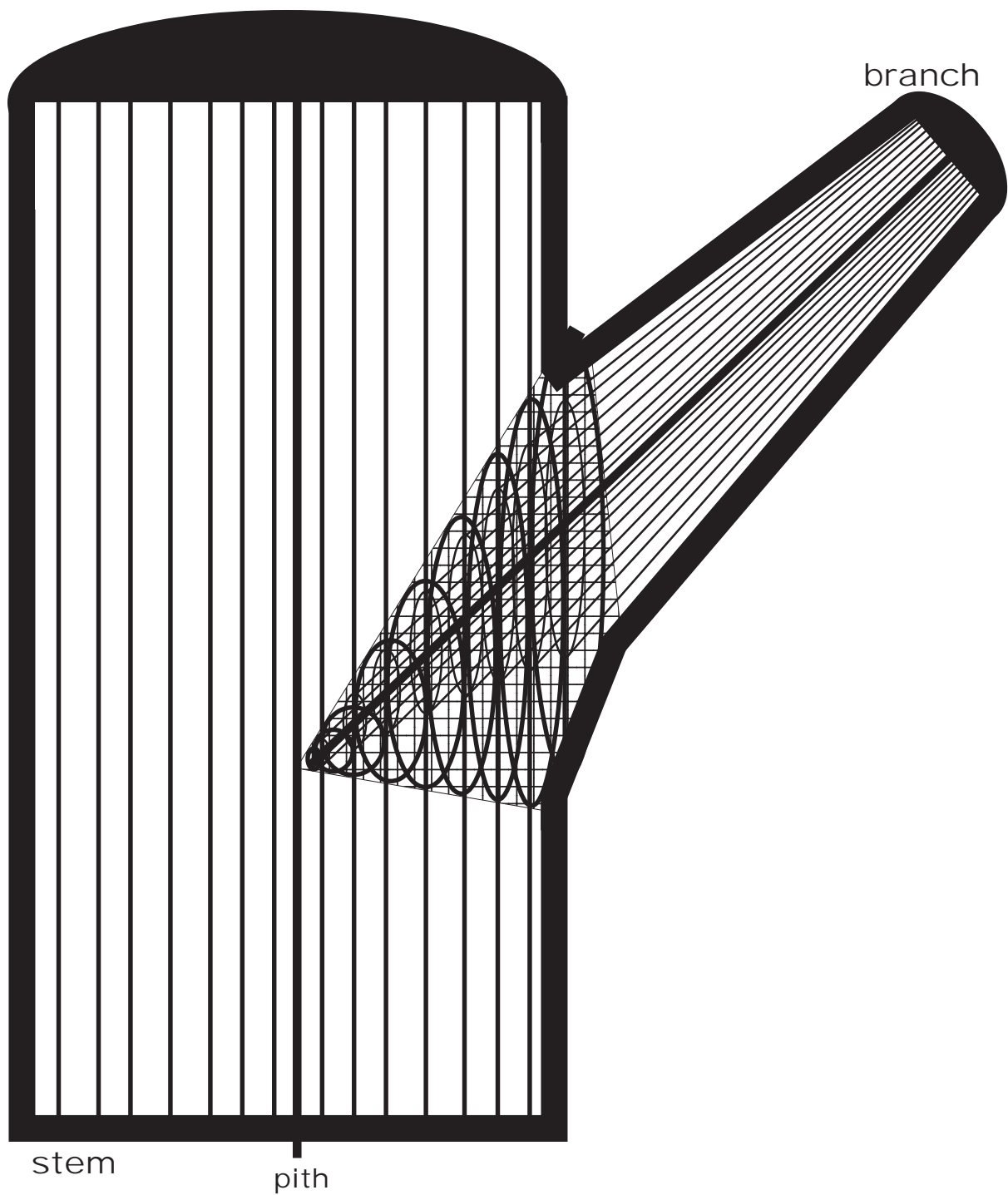

Figure 26: Diagram of stem - branch confluence area (stem flange) showing defensive zone (shaded), annual increments of tissues, and enveloping of branch tissues by stem tissues (ovals).

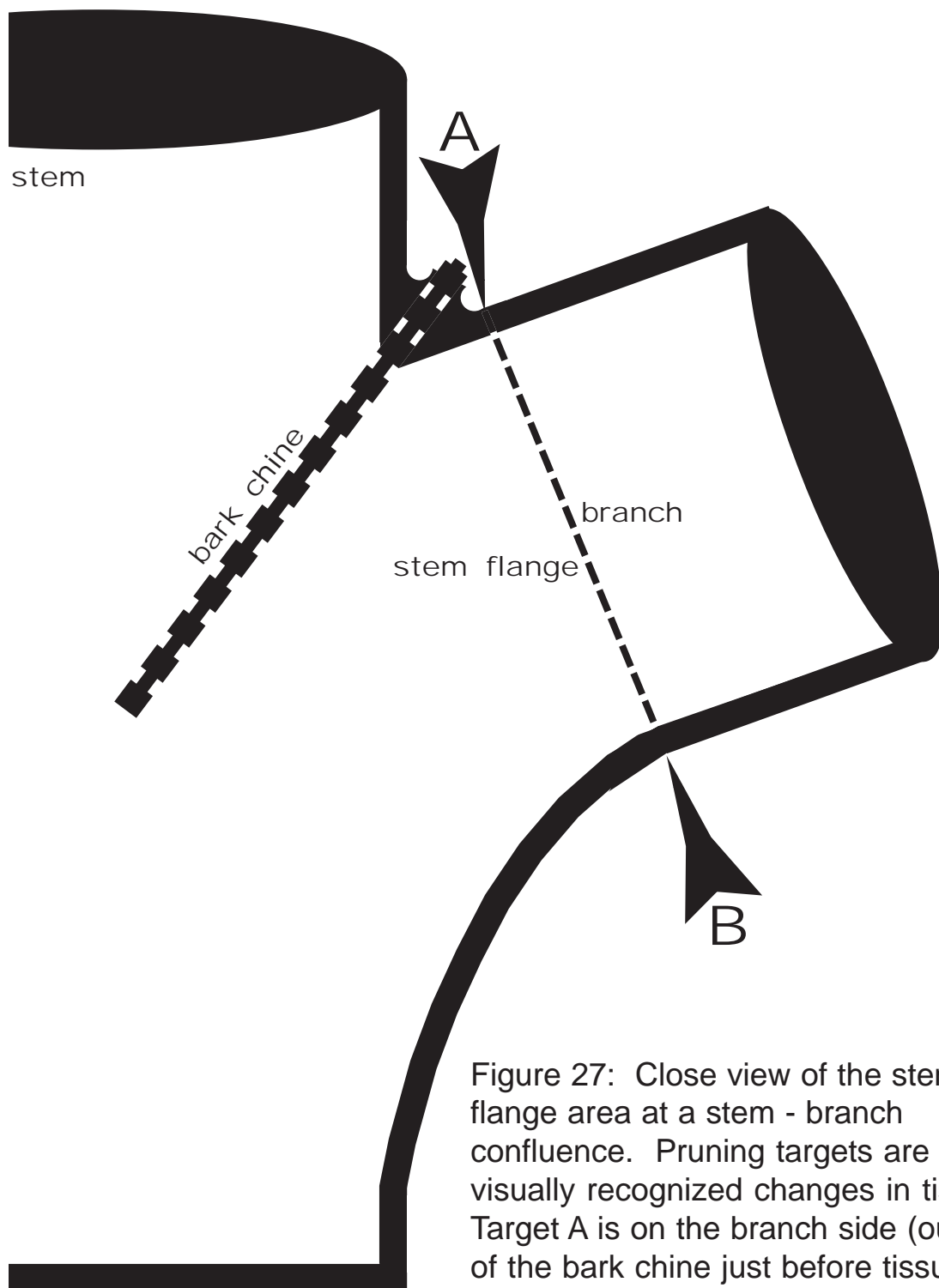

Figure 27: Close view of the stem flange area at a stem - branch confluence. Pruning targets are visually recognized changes in tissues. Target A is on the branch side (outside) of the bark chine just before tissues begin a curve up into the chine. Target B is on the branch side (outside) of the tissue swelling or gathering point on the branch underside. The dotted line between these two targets represent a two-dimensional edge of the stem flange area.

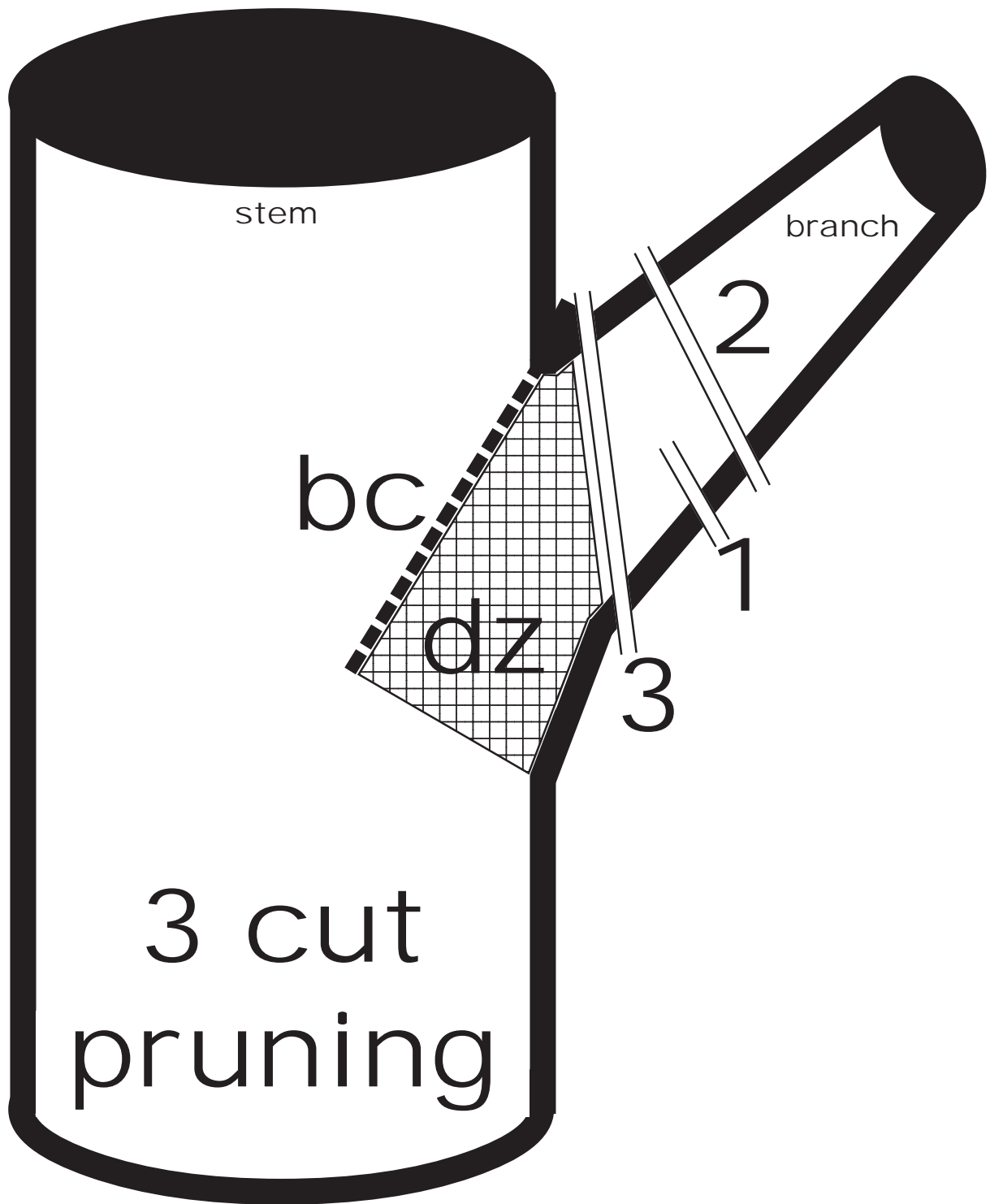

Figure 28: Diagram of stem - branch confluence area with a three-cut or target pruning prescription applied (in cut order) for a normally proportioned branch. Defensive zone = dz. Bark chine = bc.

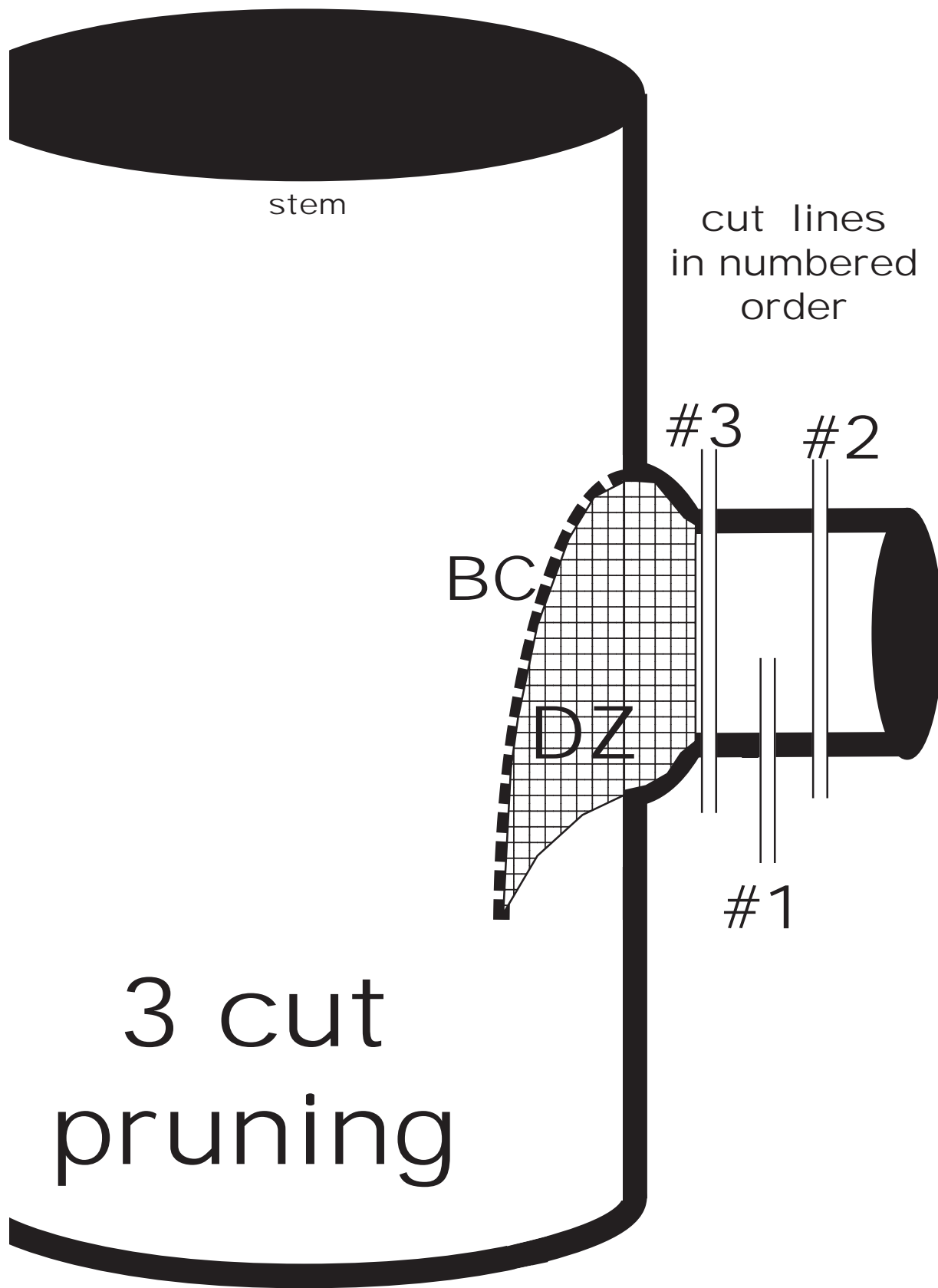

Figure 29: Diagram of a three-cut target pruning technique on a round stem flanged tree such as a gymnosperm.
DZ = defensive zone. BC = bark chine.

strates target pruning for generic gymnosperms. The one cut method of pruning a branch identifies the same targets in the branch union area as the three-cut method, but is used on small, hand-holdable branches. Figure 30.

The defensive zone at the stem flange must be left intact and undamaged after a branch is removed. Some pruning tools tend to damage defensive zones and should not be used. A clean, relatively smooth wood and bark surface should remain after pruning. Bark surrounding the wound site should be firmly attached and not scrapped. Bypass-pruners and saws should be used for pruning cuts, never anvil-type pruners.

Flush-n-Stub

Two abusive cutting techniques made by tree-illiterate people are flush cutting and stub cutting. Flush cutting removes branch tissue and stem flange area vertically even (flush) with the stem surface. Flush cutting damages, at the very least, the stem tissues above and below the wound. Flush cut wound are significantly larger than needed for branch removal and are difficult for a stem to defend because defensive zone boundaries have been breached. Figure 31. Stub cutting is topping (internodal cut) where a significant amount of branch tissue remains attached to the stem. As this branch stub dies, a large volume of dying tissue is exposed to the environment while physically interfering with a stem successfully growing over and sealing-off the stub. Figure 32.

To summarize, a critical feature of proper pruning is to leave a defendable wound area. Flush cutting and leaving stubs of various lengths prevent effective defensive responses and leave the tree open for other problems. Figure 33.

Wounds

Pruning wounds expose living and dead tree tissues to the atmosphere which accelerates oxygenation, water lose, and oxidation. Figure 34 provides a summary of tree anatomy visible across a cut wound face of a stem or branch. Open wounds are prone to invasion by a series of micro and macro-organisms attempting to use undefended growth materials and find habitat for their life-cycle. Oxidation at the wound surface immediately initiates a compartmentalization response in a tree, sealing off from the environment the inside of a tree. If defensive zones are not breached, rays cells will begin a growth and closure process, eventually sealing off and sealing over wound sites.

If the pruning targets presented at the stem-branch confluence site are recognized and conserved, a wound closure from all sides will develop. If the defensive zone is breached on any side, particularly top and bottom of the wound as occurs in flush cutting, wound closure will occur primarily from the sides pushing into the center. This wound closure pattern of tree-illiterate pruning will form a longitudinal line or crack. Figure 35. The compartment lines set around this abusive pruning wound can lead to a number of other aesthetic, structural and biological problems later on in the life of a tree, some life threatening. Proper wound closure is not a long crack, sometime perpetually open, but a single point soon grown over.

Wait Cuts

For a branch approaching $2/3$ s the same diameter as a stem at its branch union, defensive reactivity and effectiveness are greatly reduced. Proportionally large diameter branches (codominant branches) do not have strong defensive zone and are difficult to prune. The structural targets easily identified on proportionally small branches are veiled or do not exist in codominant branches.

Pruning wounds of codominant branches have a great risk of tissue drying, oxygenation and decay, as well as providing a greater opportunity for pest entry. Pruning cuts on codominant branches should attempt to preserve any residual collar that may exist. Erring on leaving slightly too much of a stub is

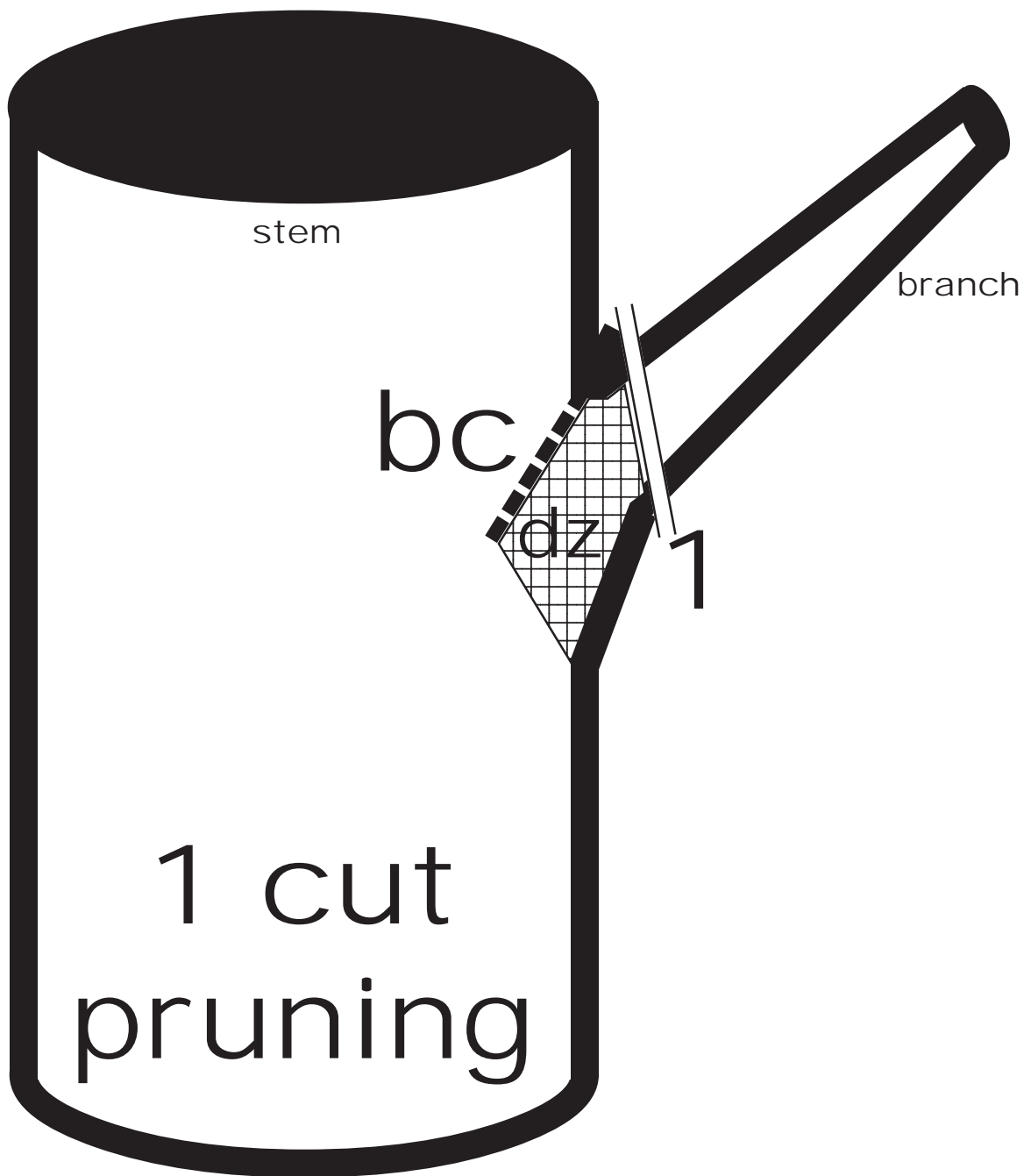

Figure 30: Diagram of stem - branch confluence area with a one-cut pruning prescription applied for a small proportioned branch. Defensive zone = dz. Bark chine = bc.

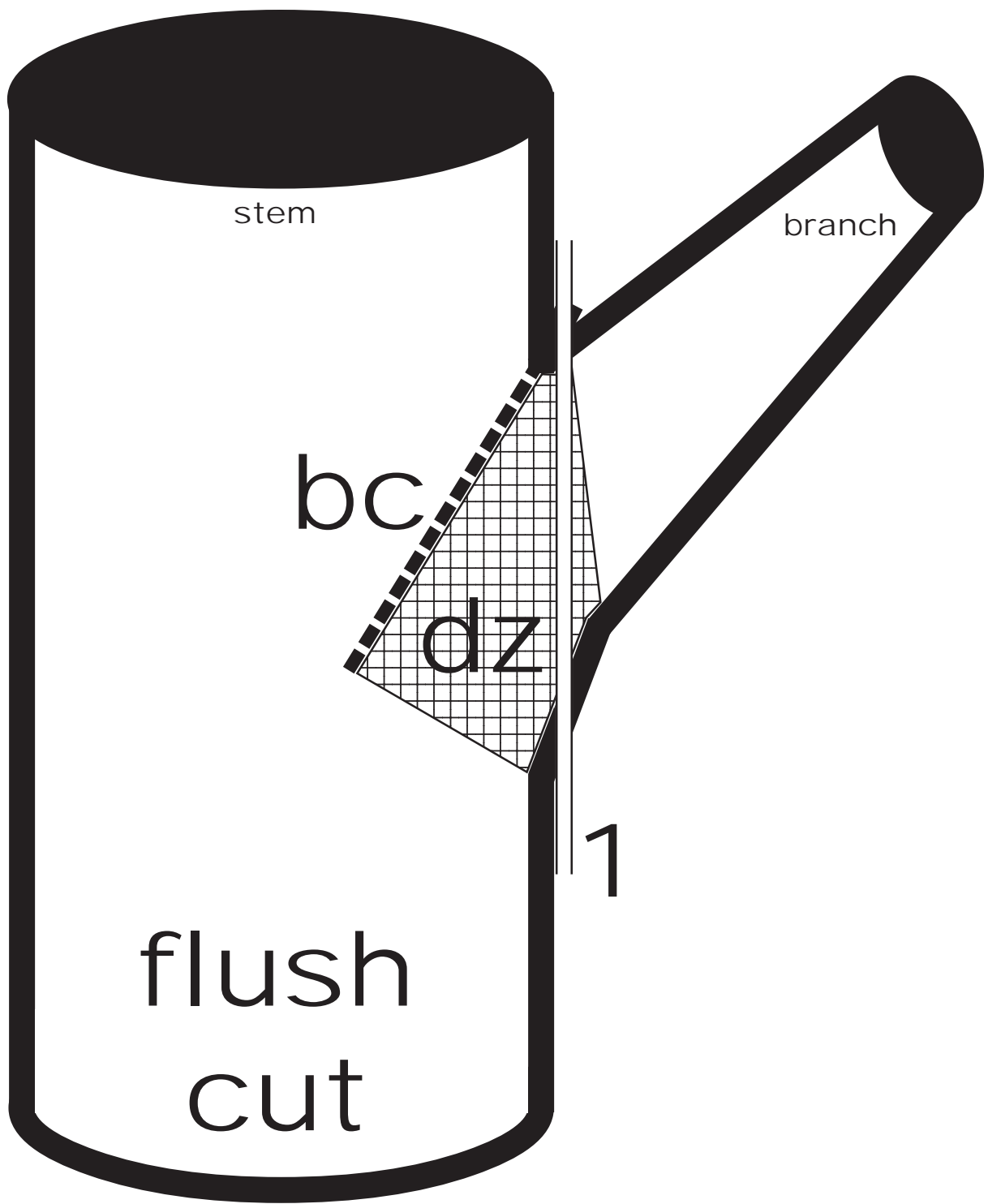

Figure 31: Diagram of stem - branch confluence area with an abusive, improper flush cut applied. Defensive zone = dz. Bark chine = bc.

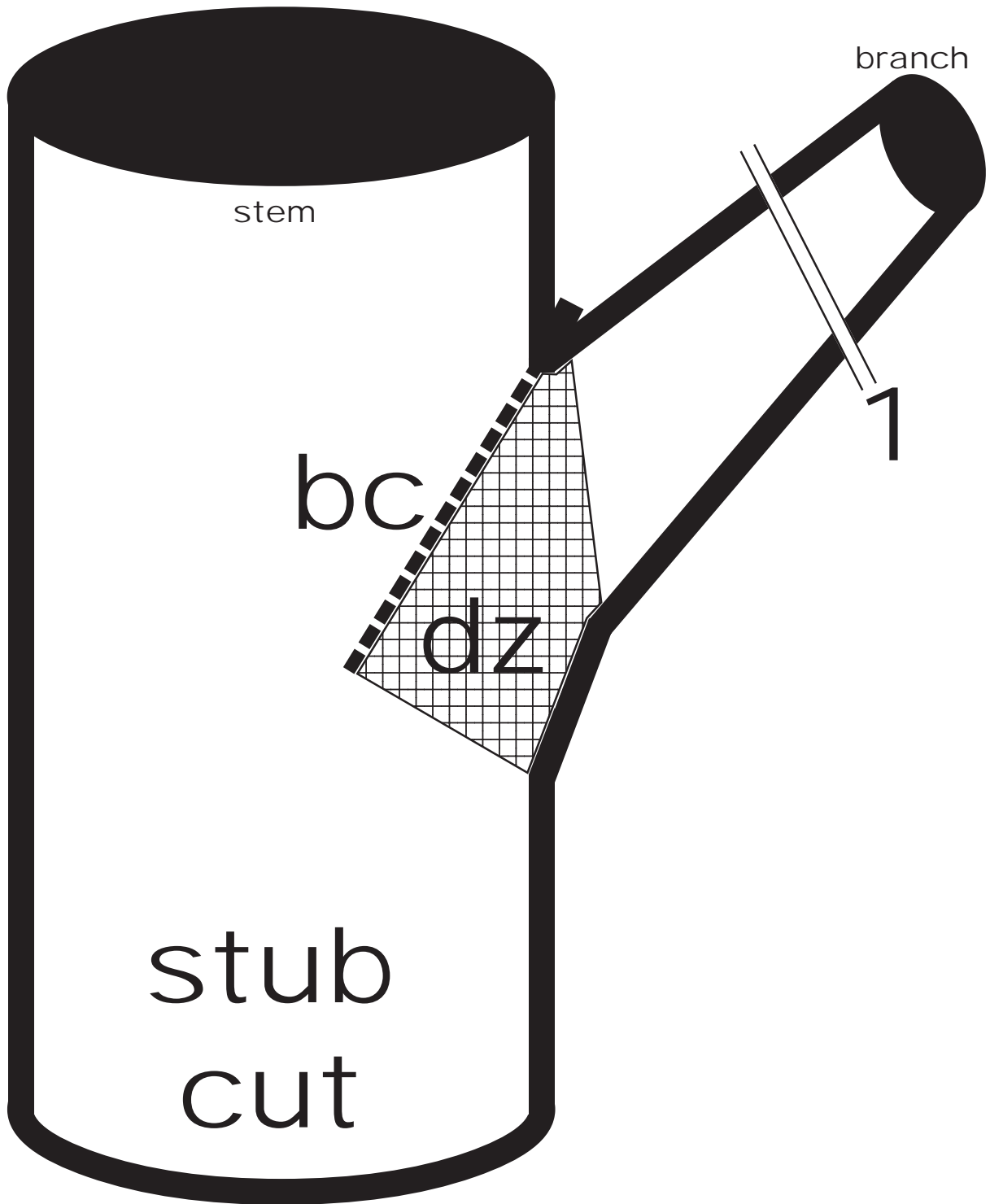

Figure 32: Diagram of stem - branch confluence area with an abusive, improper stub cut applied. Defensive zone = dz. Bark chine = bc.

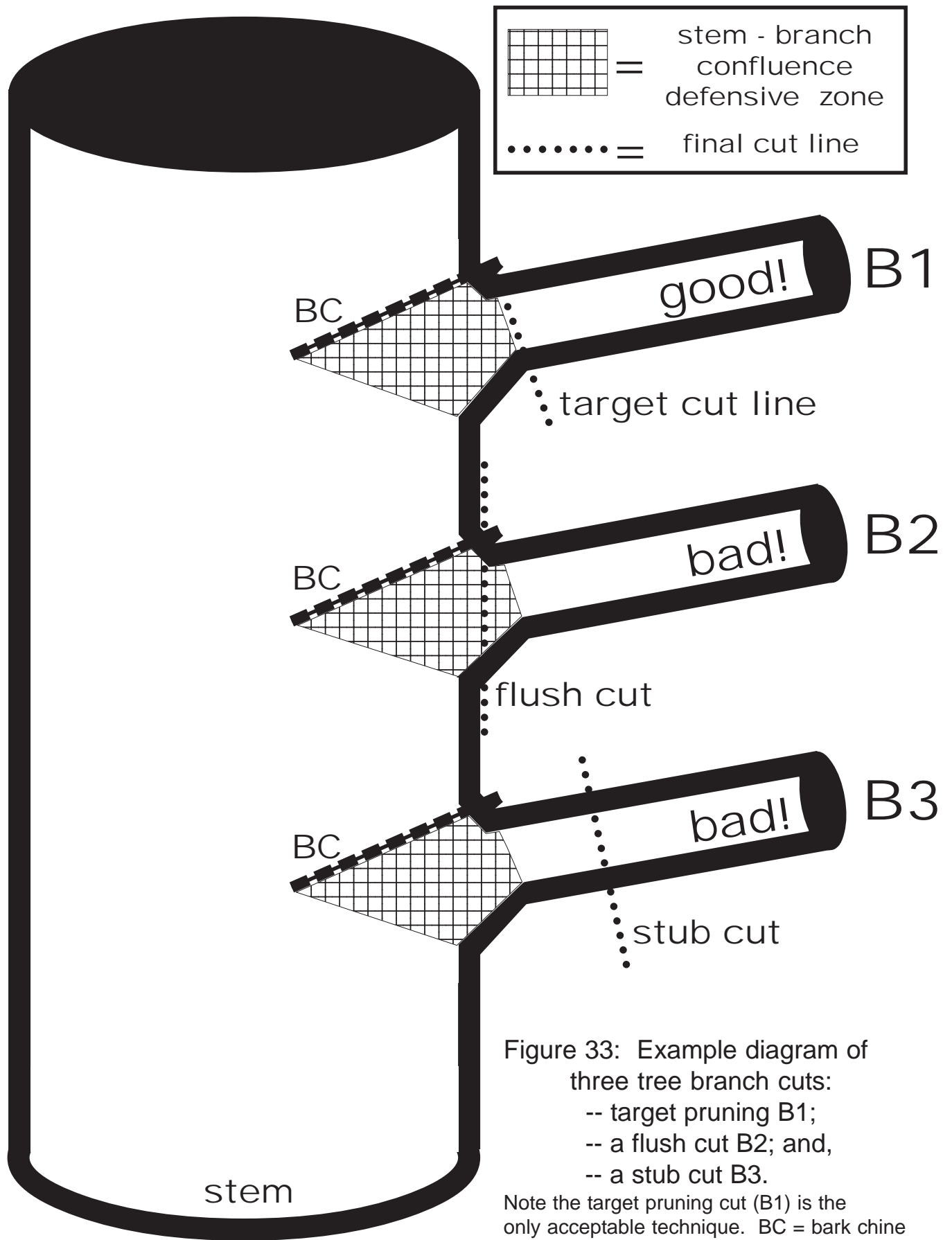

Figure 33: Example diagram of three tree branch cuts:
 -- target pruning B1;
 -- a flush cut B2; and,
 -- a stub cut B3.

Note the target pruning cut (B1) is the only acceptable technique. BC = bark chine

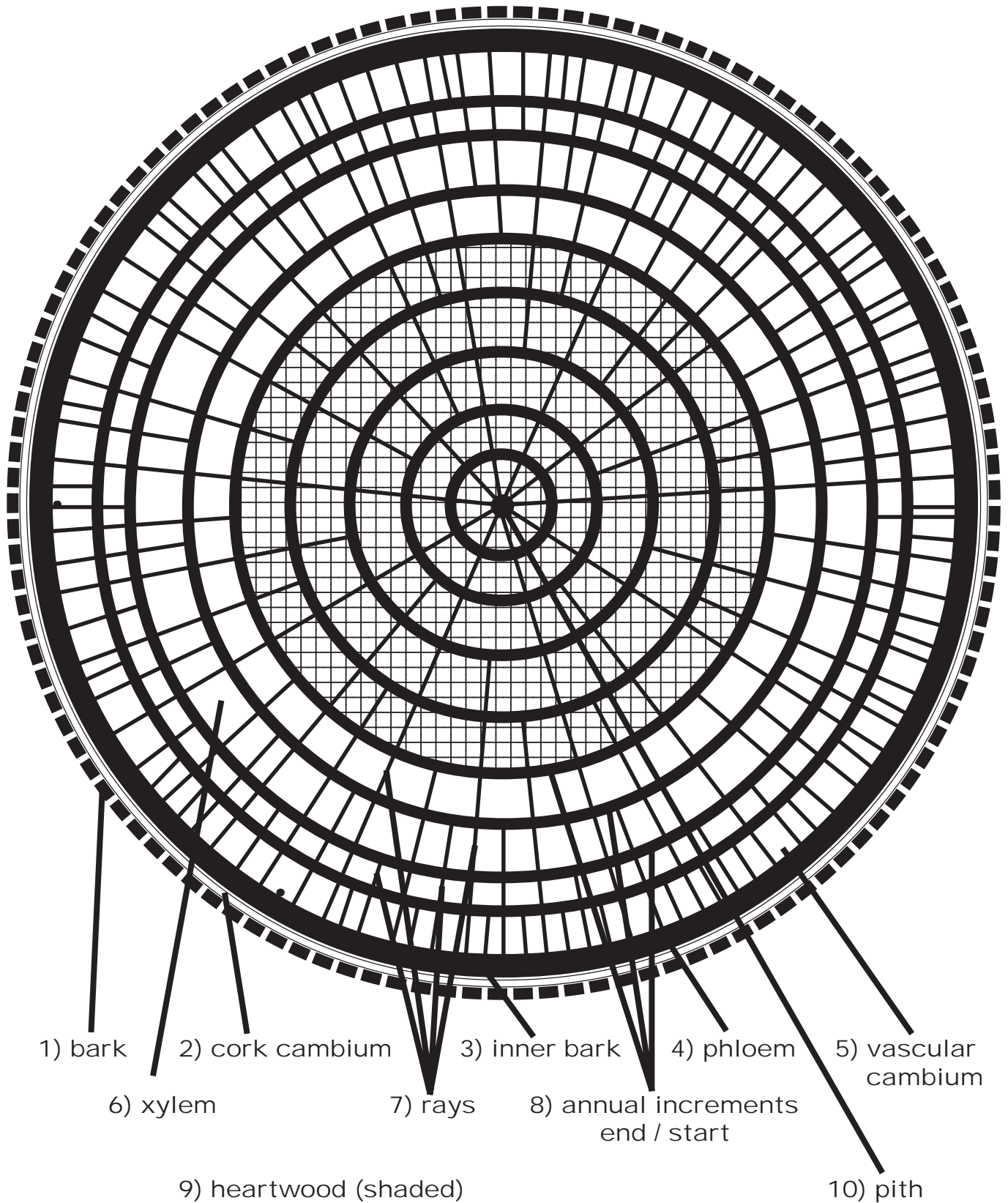
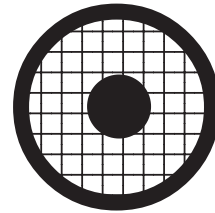

Figure 34: Diagram of generic stem or branch cross-section and different tissues / layers crossed when pruning, in numbered order from outside / surface.

proper pruning
wound closure
(circular to a point)



improper pruning
wound closure
(longitudinally
elongated to a crack)

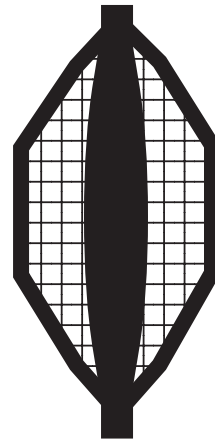

Figure 35: Diagram of a pruning wound closure or seal from a properly executed branch pruning (top), and an abusive, improper flush cut (below) on the same diameter branch.

preferable to flush cutting with codominant branches. If your prescription includes pruning many codominant branches, then you waited too long to begin a pruning program.

Shortening

Pruning cuts in a tree are not always simple branch removals -- pruning cuts of proportionally smaller branches on larger branches and stems. Another pruning cut is used to reduce the reach and extent of a branch or stem, not to be removed. This pruning cut removes proportionally large stem, leaving at the terminus a proportionally smaller branch. Unfortunately there is no established defensive zone. Figure 36 demonstrates the targets for reduction pruning.

For a reduction cut, first a line perpendicular to the main axis of the stem or branch to be removed must be established anchored at the top of the stem-branch confluence. Next a lift line is established parallel to and above the perpendicular line by a distance "L". This distance is roughly 1/9 stem diameter at this location, or at least three times saw kerf thickness. Figure 37 demonstrates the proper 3-cut pruning process for reducing a larger stem or branch back to a smaller, but active lateral branch. The stem - branch confluence selected as the reduction point should always have a lateral branch at least 1/3 the diameter of the stem to which it is connected. The final cut line is a 30° down angle from the lift line intersection with the stem over top of the stem-branch confluence.

The target for reduction pruning is centered around bark chine location. Targeting the reduction cut is to assure the greatest tree defensive response possible for such a large wound. Because of tissue drying and potential heartwood exposure, these wounds can be difficult for trees to seal off and grow over. Follow reduction pruning targets and cut line geometry given in Figure 37. The distance above the stem - branch confluence and bark chine is key. A slanted final cut, not perpendicular to the stem or branch being removed, does leave a larger wound area but should be positioned to not collect water. The angle is not nearly as critical as a clean smooth cut and not damaging tissues near the bark chine.

Forked

Removal of one side of a forked stem follows a similar procedure as above. Figure 38 provides target lines for setting up a proper pruning cut. First a line roughly perpendicular to the main stem axis is established resting on the top of the stem-branch confluence. This line is called a nexus line. A lift line is then established parallel to and above the nexus line by a distance "L". As before, the distance L is 1/9 the stem fork diameter in the cut area, or at least three saw kerf thicknesses. A 30° down angle cut line is then established anchored to where the lift line and the stem fork meet over stem - branch confluence. Figure 39 shows the three-cut method for removing one of the stem forks.

Figure 40 shows the set-up and three-cut removal of a codominant branch / forked branch. A nexus line is established at the top of the confluence. The nexus line is perpendicular to the main longitudinal axis of the stem or branch below the fork. The lift line is placed a distance "L" above, and parallel to, the nexus line. The distance L is 1/9 diameter of the codominant branch for removal, or at least three times the saw kerf thickness, beyond the nexus line. The final cut line is a 30° angle to the lift line anchored above the top of the confluence.

Topping

Topping, or internode cutting is one of the most abusive biologically, damaging structurally, and disfiguring treatment applied to trees. Topping in all its many guises and fanciful names is an abomination on trees and the people who care for trees. An internode cut is an untargetted and uneducated slice with a cutting tool. Figure 41. An internode cut is not made at a node where some defensive capabilities exist, but is made somewhere along an internode where damage can be severe and the wound poorly defended.

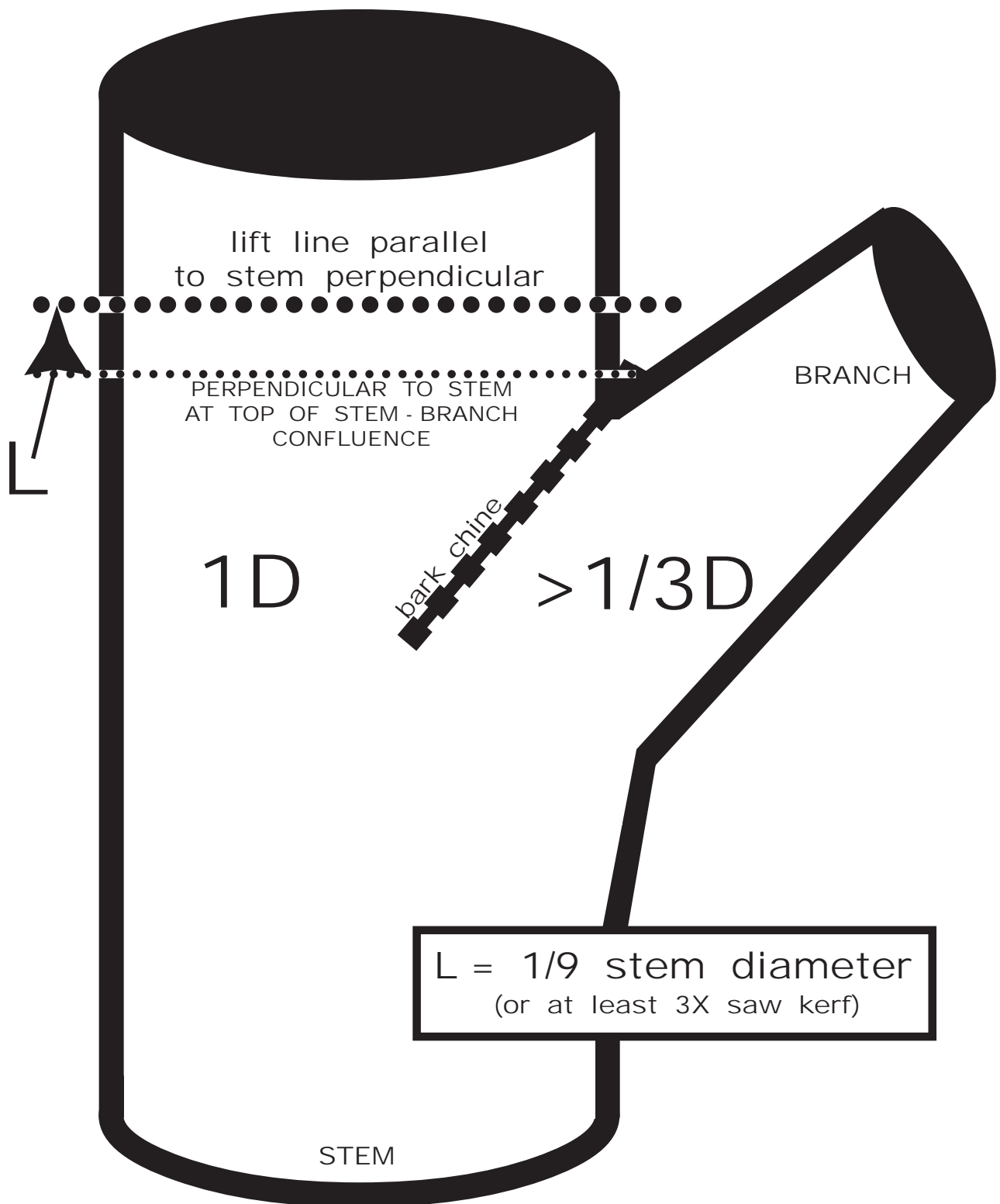

Figure 36: Diagram of stem - branch confluence with target lines for initiating a reduction pruning cut. Note stem of given diameter will be reduced to a branch never less than 1/3 its diameter. "L" is lift line distance above the perpendicular across the stem at the top of stem - branch confluence.

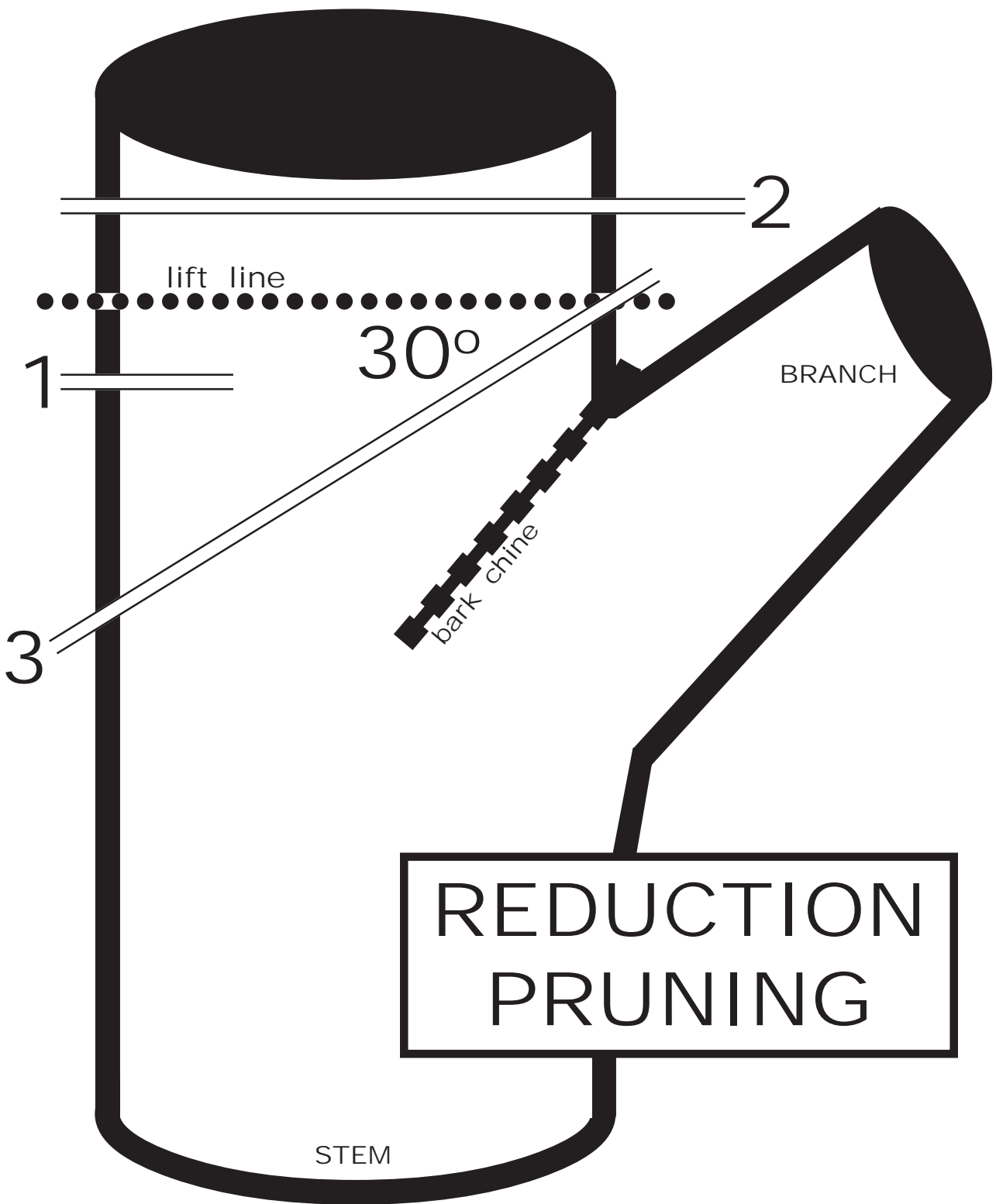

Figure 37: Diagram of stem - branch confluence with three cut lines, numbered in order, for a reduction pruning prescription. Note the final (3rd) cut is at 30° down angle from the branch side of the lift line. The down angle is not dependent upon the bark chine or branch angle.

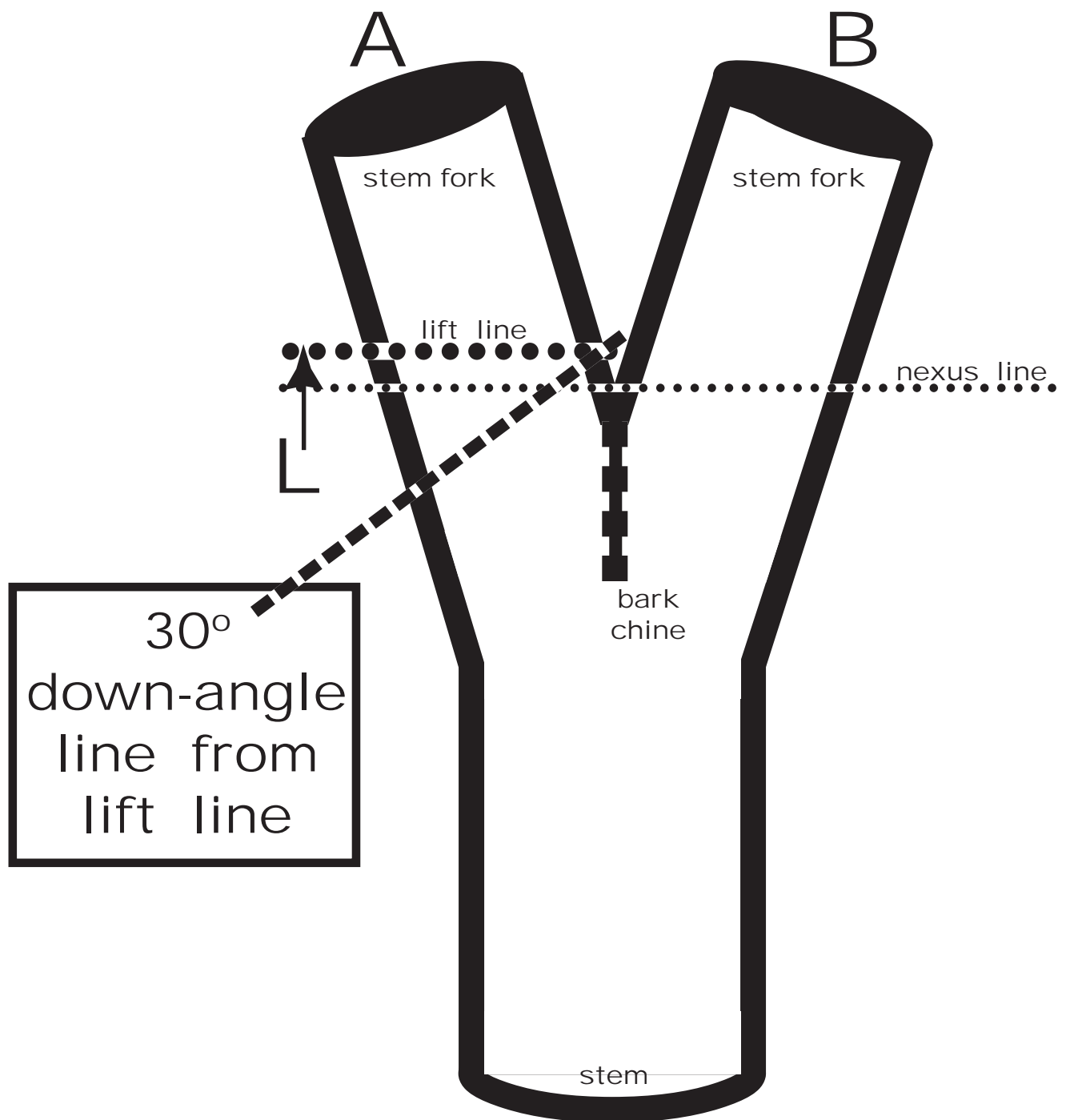

Figure 38: Diagram of forked stem with target lines established to initiate a reduction pruning prescription on stem fork A (left fork). Note the lift line is made parallel to and above the nexus line which is perpendicular to the longitudinal axis of the main stem before the fork and anchored at the top of the stem - branch confluence. L is 1/9X stem fork A diameter, or at least 3X saw kerf.

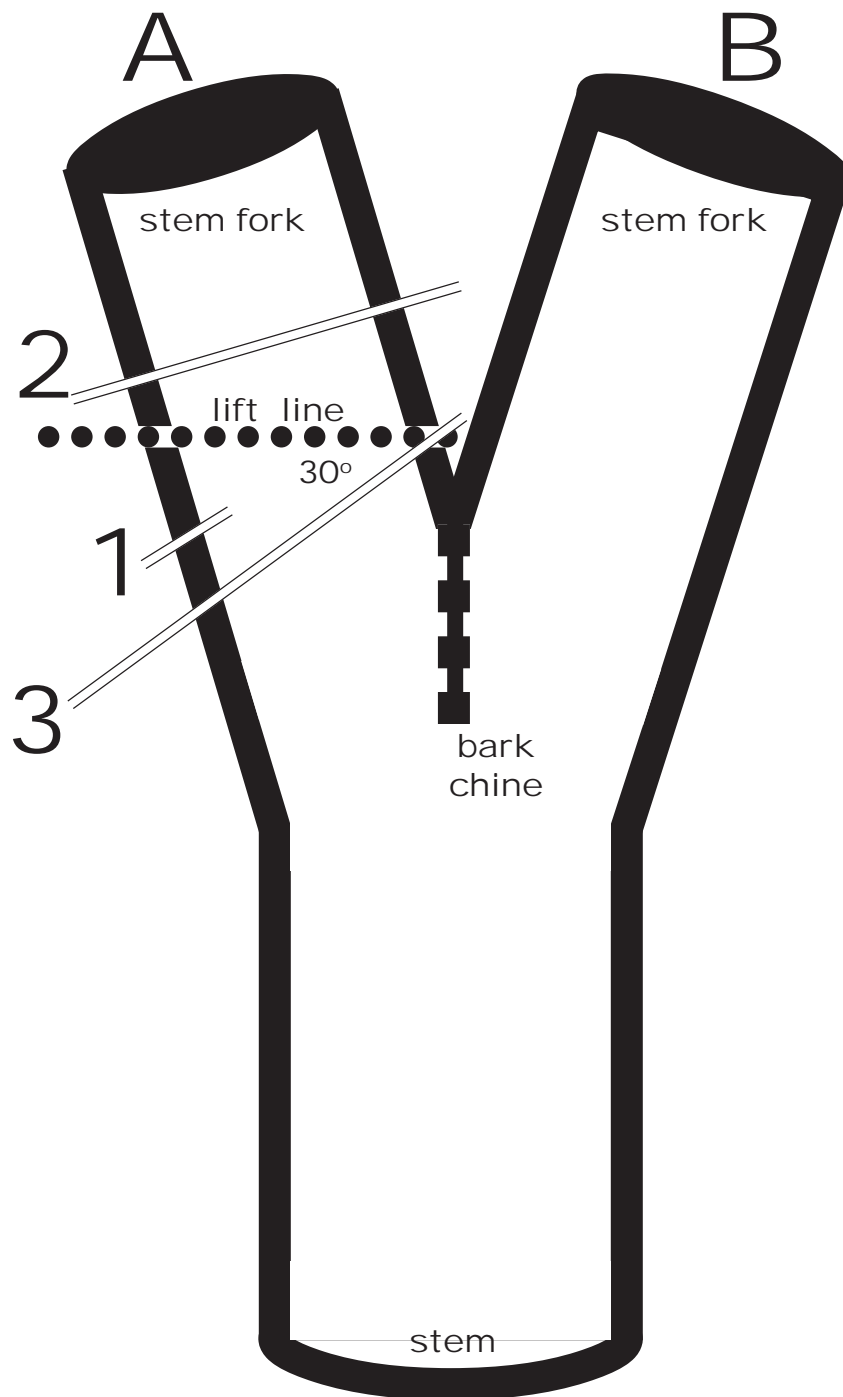

Figure 39: Diagram of forked stem with 3 cut lines placed in numbered order for a reduction pruning prescription on stem fork A (left fork). Note the final (3rd) cut is at a 30° down-angle from the lift line beginning above the top of the stem fork nexus. The down angle is not dependent upon the bark chine or stem fork angles.

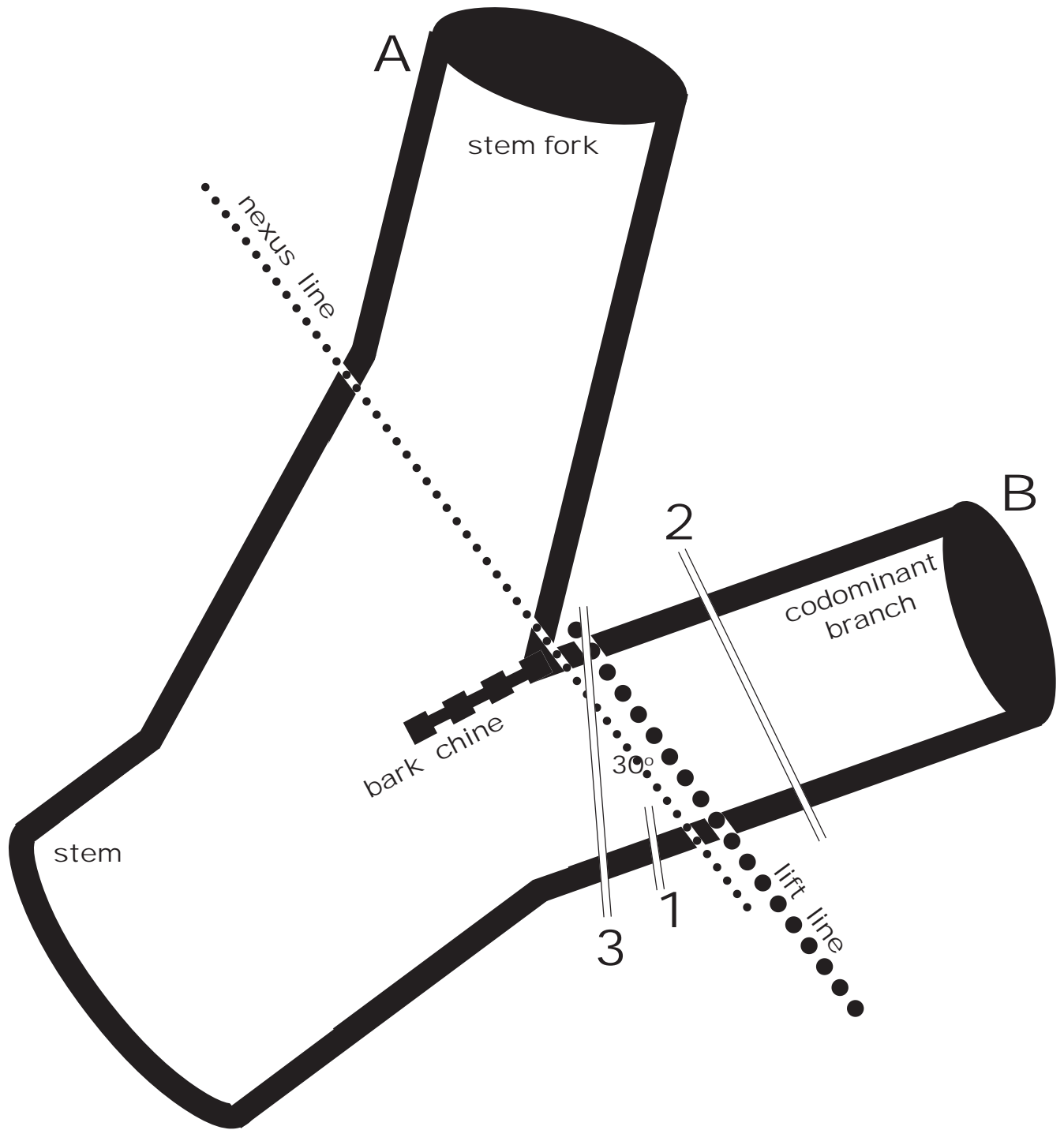

Figure 40: Diagram of a 3 cut (in numbered order) reduction pruning prescription on a codominant branch / fork (B). The final cut (3rd cut) is at a 30° angle from the lift line anchored above the nexus of the codominant branch and stem fork.

internodal cut

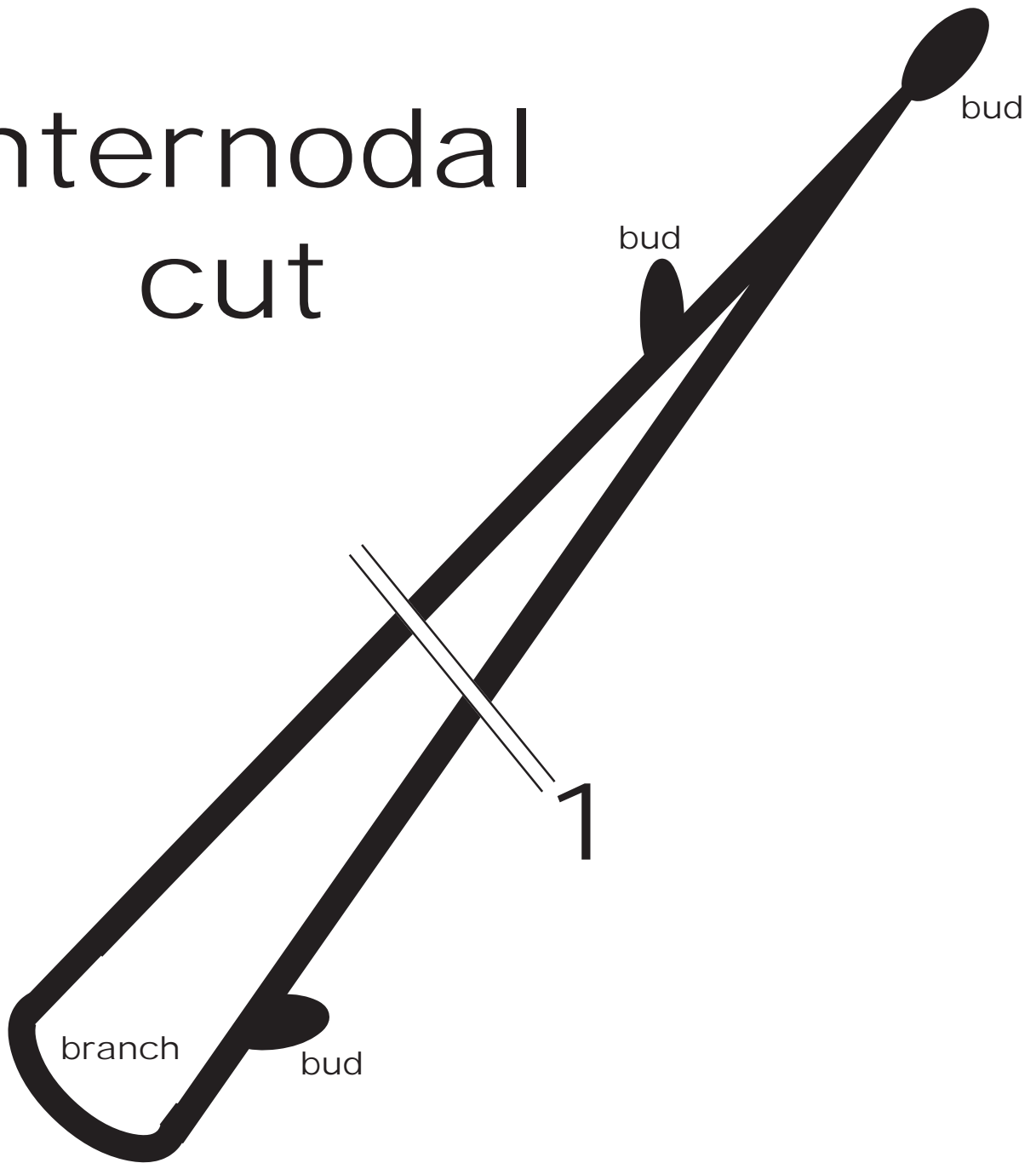

Figure 41: Diagram of an abusive, improper, and damaging internode cut. Other terms used for this abusive cut include topping, tipping, hedging, hat-racking, & trimming. It is not the size of tree part cut (stem, branch, or twig) but the internodal location which makes this cut improper and damaging.

Figure 42 provides an example of a topping cut on a stem and a branch. Topping cuts are made with no care for survivability of the remaining tree, or for future health, structural integrity, or aesthetic value.

Branch Positions

It is important each branch has good structural integrity, is biologically efficient, and positioned to add to whole tree aesthetics. In order to accomplish these goals, branches must be well distributed along and around the stem. Light capture is the principle task of a branch, twig, and leaf system on a tree. Assuring branches are positioned where each can make sufficient food for itself and the rest of the tree below is the task of prescribed pruning. Branch spacing must be sufficiently widespread for adequate light capture while minimizing direct tissue shading, at the same time minimizing wind driven movements which injure leaf tissues and surrounding branches.

Branches should be ideally positioned to minimize direct shade effect distances and utilize full sun, sun flecking, and diffuse shade resources. Branch occupied resource space must be filled with both a good quality and quantity of light. Selecting which branches to conserve and to prune must be based upon the number of leaves, number of twig orders present, branch length, and total volume occupied per leaf area. No branches should be maintained which shade each other, parallel another in its primary growth direction, share significant resource space volumes, or touch under wet, normal growing season conditions and wind loads.

Under ideal conditions, approximately twelve to eighteen individual branch resource spaces can be delineated, each containing a single, healthy, structurally sound branch which adds positive values to whole tree aesthetics. The number of individual branch resource spaces can be modified as leaf effective shade diameters and associated direct shade distances change. The geometry of how leaves are arrayed for light capture is critical to understand in delineating branch resource spaces along a stem.

Space Management

Taking space which contains essential light and CO₂ resources, and distributing these resources across a finite number of leaves held effectively by structural tissues connecting leaf factories to soil based growth resources, is difficult. Trees maintain leaves, twigs, and branches at various levels of productivity as part of a reactionary redundancy in case of disaster or stress. Tree health care specialists, like all landscape managers, attempt to assemble tree components to meet multiple goals and objectives, including meeting expectations of surrounding humans. Pruning prescriptions are designed to have the best looking, best performing, biologically healthy and structurally sound tree possible. Depending simply upon natural tree genetic / environmental interactions, plus chance, to reach landscape goals can provide undesirable and unreliable results.

In pruning prescriptions the top two-thirds of a tree should ideally contain twelve to eighteen equal volume resource spaces. One branch should ideally be positioned to utilize each resource space. Branches are distributed in this way primarily to minimize two or more branches from occupying the same resource space and growing along the same light interception path for a significant portion of the day. Effective distribution of these branches represents an optimum packing density. Packing of leaves along a twig, twigs along a branch, and branches along a stem have genetic, environmental, and chaotic components. In this prescription process, only the branch on stem distribution will be emphasized.

Branch Helix

The distance between stem - branch confluences can be highly variable in effectiveness at gathering resources and holding resource space. Much of this variability is derived from competitive interactions with neighboring trees, topography / aspect, and human objects impacting branch success

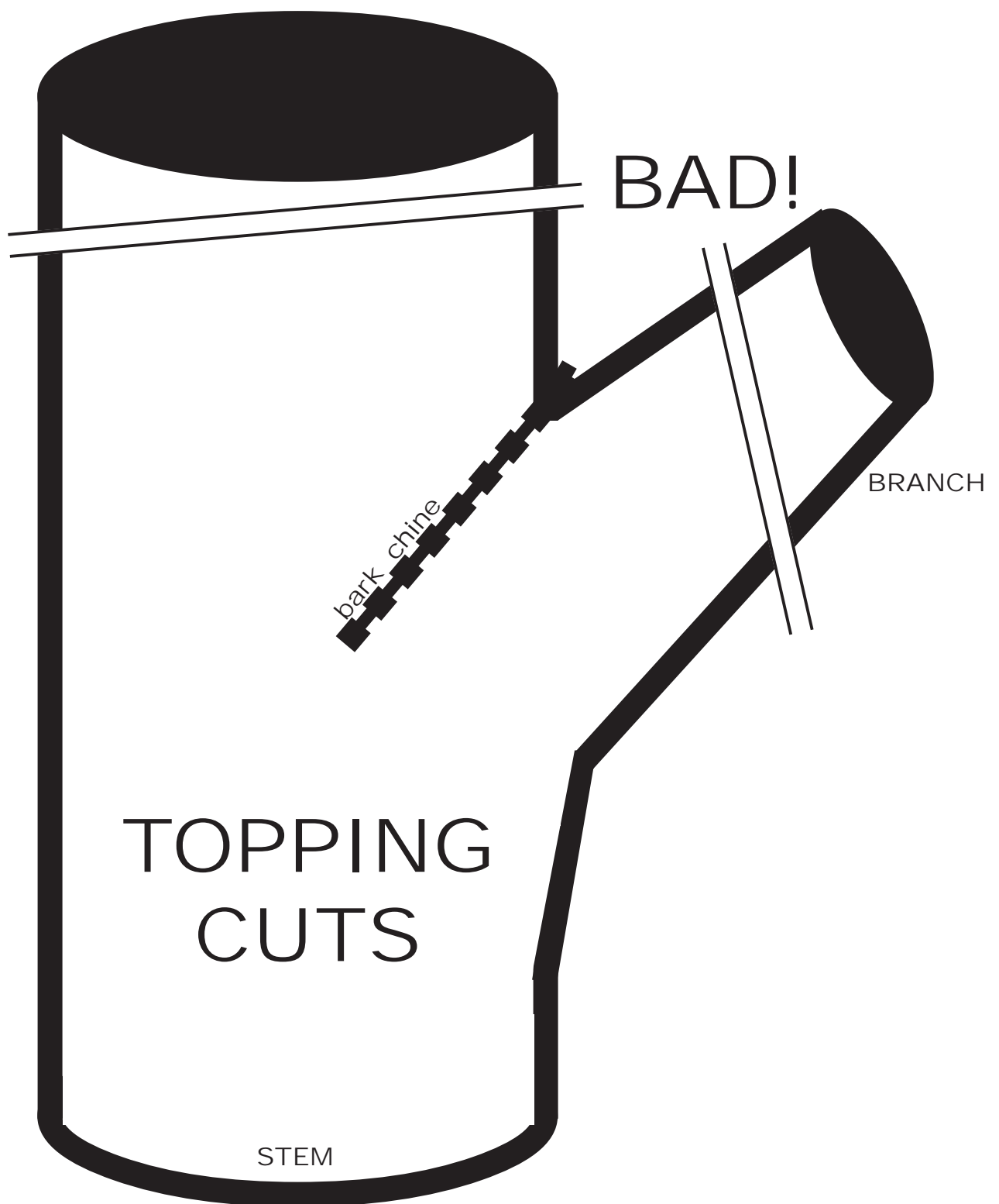

Figure 42: Diagram showing abusive and damaging topping (internodal) cuts on a stem and branch.

starting from its first year. One successful branch can inhibit other branch successes nearby. Due to direct shading effects and light impact angles during growing season days on the tree crown, small short branches at the crown top can be somewhat closer together than large long branches near the live crown base. Upper branches can partially overlap lower branches because the lower branches are longer, holding leaves farther into valuable resource space.

For ease of understanding, the twelve to eighteen resource spaces around each branch of an ideal crown will be distributed around and along the stem in a helix. Figure 43. Branch confluence positions are determined by optimum packing density. In many natural systems the packing density of leaves, twigs or resource gathering tissues are offset to prevent one from being directly above or beside the other. The offset seen often approaches the golden angle or golden proportion of a circle ($360^\circ \times 0.382 = 137.5^\circ$). See Figure 2. Here the golden angle of 137.5° is approximated with a simple green angle of 135° ($90^\circ + 45^\circ$). From crown top to bottom, each vertically adjacent stem - branch confluence area is separated around the stem circumference from each other by the green angle of 135° . Figure 44.

Space Between

The vertical distance between stem - branch confluence is determined by dividing live crown height (in feet) by the number of resource space volumes or branch positions plus the terminal position. For example for twelve branch positions, divide live crown height by 13 ($12 + 1$). For eighteen branch positions, divide live crown height by 19 ($18 + 1$) for the vertical distance between confluences. The resulting value is a vertical distance (in feet) between consecutive stem - branch confluences, although they would be off-set along the branching helix by 135° , the green angle. Figure 45 provides the idealized vertical distance in feet between stem - branch confluences for given live crown heights (not total tree height).

Within the top third of total tree height, or top half of live tree crown, a total of six to nine resource space volumes with a single branch should be maintained. Two to three of these branches should arise from portions of the stem within each of the three pie-shaped subdivisions (i.e. wedges). Two to three stem - branch confluences would be in each of the three wedge shaped resource spaces. Each confluence would never be directly above another except in the 1st and 9th branch position (8 branch positions apart vertically). (See Figure 43 & Figure 44). A total of six to nine branches should also be ideally maintained within the middle third of total tree height or bottom half of live crown. Two to three branches should arise from portions of the stem in each of the three pie-shaped subdivisions.

Distribution

For a whole tree, a total of 12-18 stem - branch confluences, divided into 6-9 confluences for both top and bottom halves of the living crown, would be maintained. Around the circumference of the living crown, each vertical third would have 4-6 stem - branch confluences, 2-3 in each resource space wedge. See Figure 46. All branches should be well distributed around and along the stem. No two neighboring branches (physically close branches) should share the same position horizontally or vertically on the stem. Every branch would always be separated from its nearest neighbor around the stem by 135° and by a vertical distance of $[1 / (\text{branch confluence number} + 1)]$ the height of the living crown. Any stem - branch confluence would only have another confluence directly above or below it vertically every 8 branch positions.

Strength

For long term structural stability, only one stem - branch confluence should be allowed to disrupt and part the longitudinal fibers of the stem along the same vertical or horizontal line.

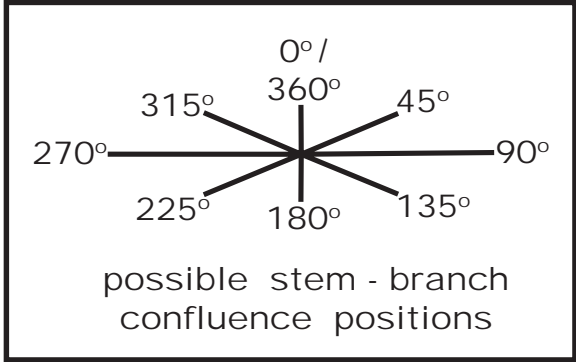
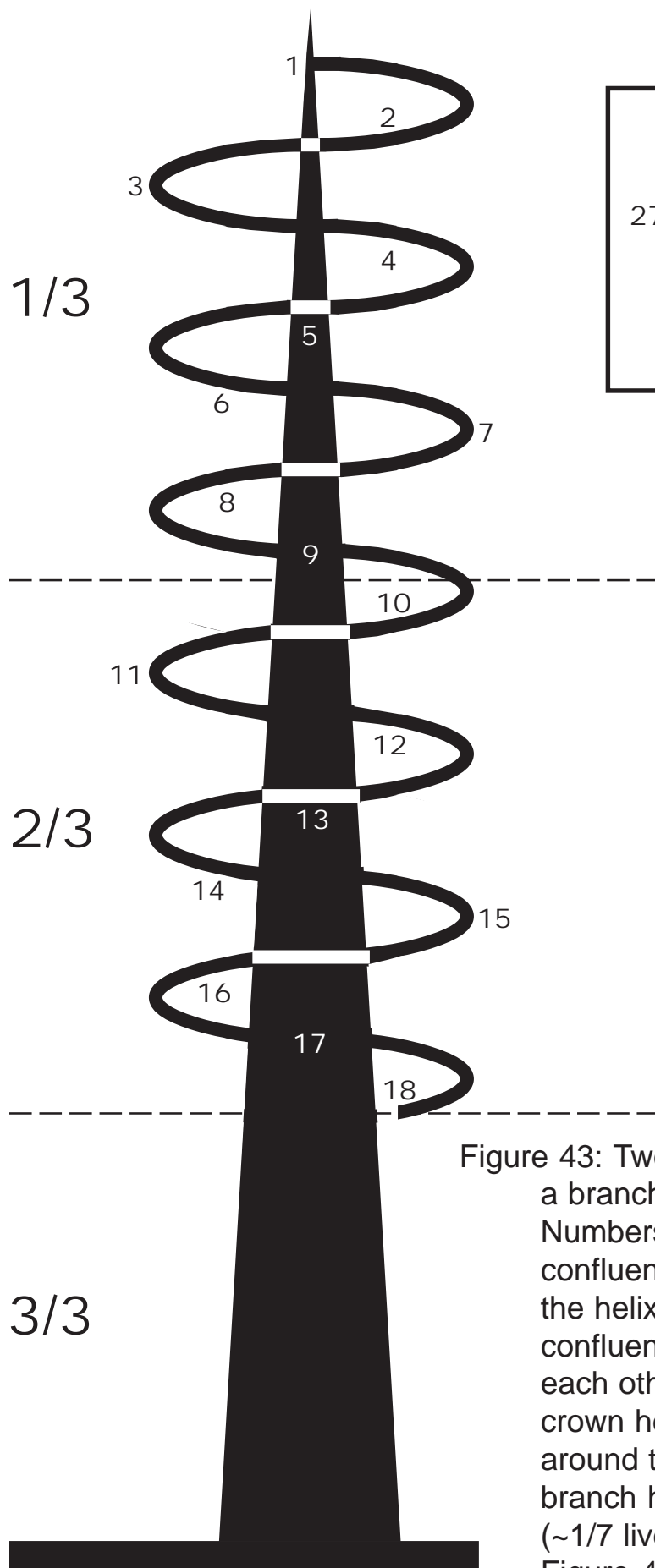

Figure 43: Two dimensional diagram showing a branch helix draped over a tree stem. Numbers represent 18 stem - branch confluences in numbered order along the helix beginning from tree top. Each confluence is vertically separated from each other, in this case, by 1/19 live crown height and 135° horizontally around the stem. Each loop of the branch helix is 2.67 confluences apart (~1/7 live crown height apart). See Figure 44.

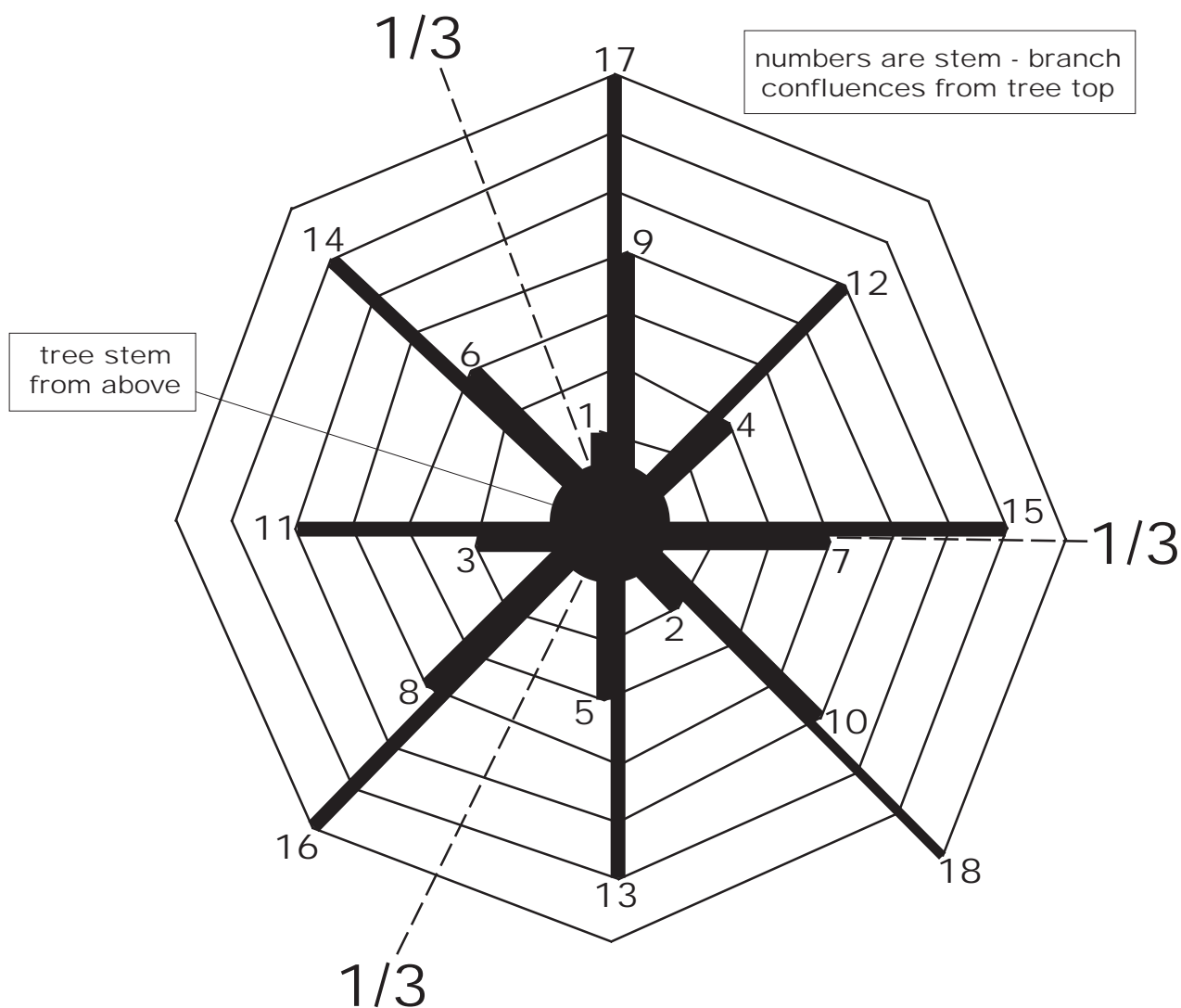

Figure 44: Ideal distribution or packing density of 18 branches within the live crown of a tree as seen from above. Branch confluences are numbered starting at the crown top with number 1, proceeding down and around the stem. Each branch is separated from the next branch, in this case, above and below by $1/19$ live crown height and by 135° stem circumference. The live crown is divided into vertical thirds with six branches in each third. See Figure 43. Note distribution is along a branching helix (i.e. conical helix), not a spiral form as shown.

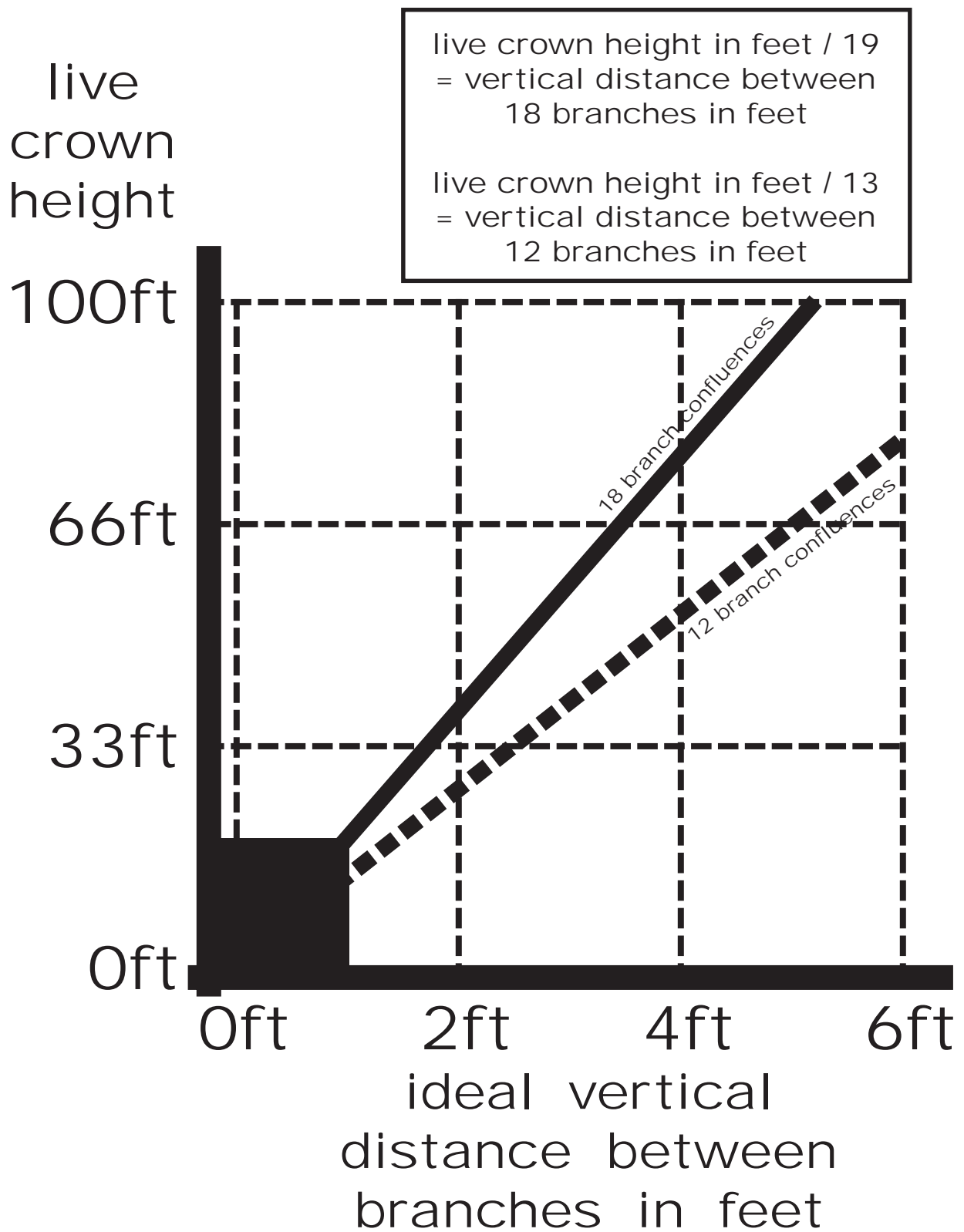

Figure 45: Graph of vertical distance between branches in feet along an upright dominant stem.

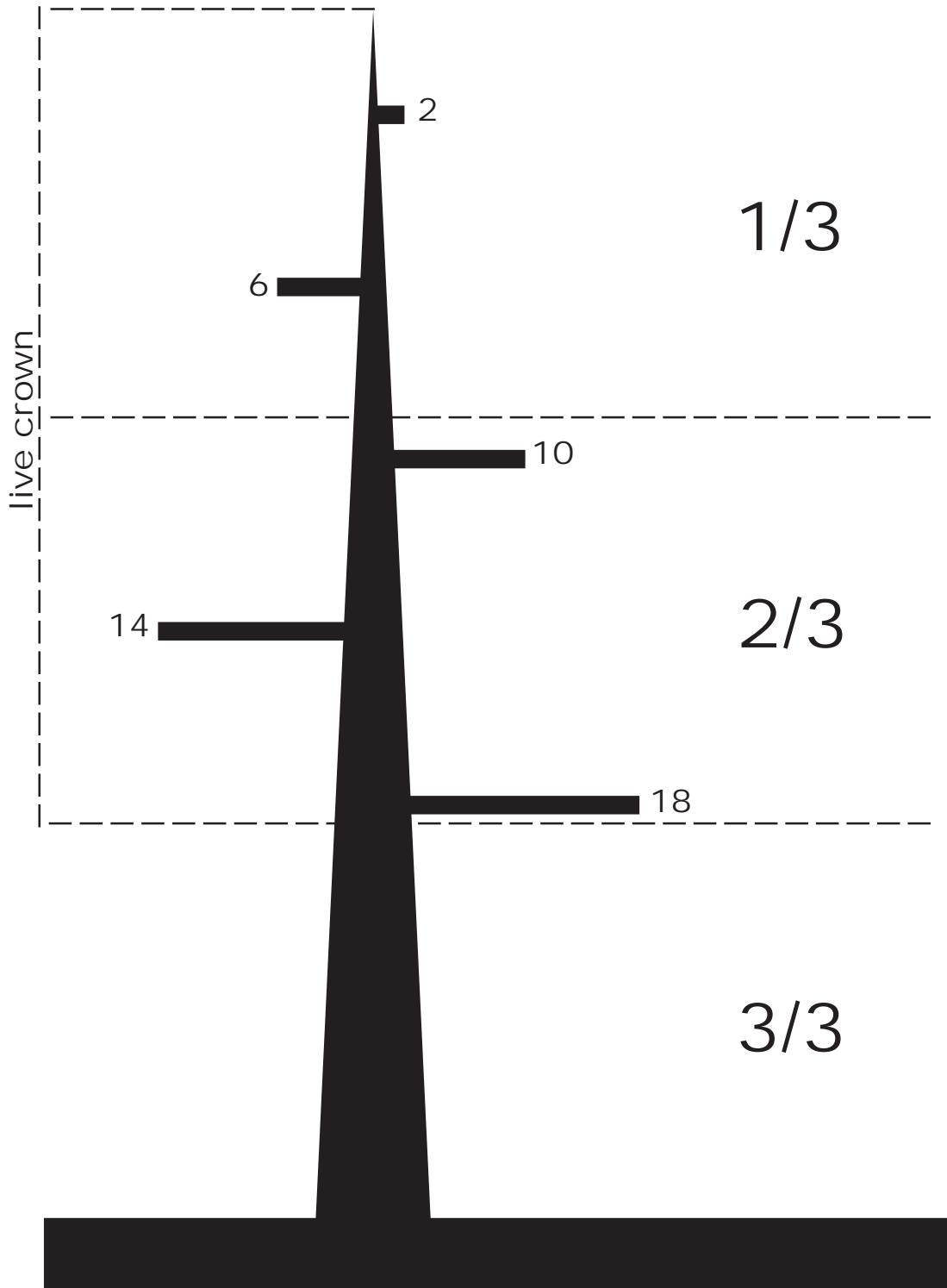

Figure 46: Ideal distribution of five branches distributed on one vertical plane within 18 resource space volumes around and along a tree stem listed by stem - branch confluence order number. See Figure 44.

Branches should always be maintained in a roughly alternating or helically separated pattern. Branches which arise from the same horizontal place (circumference) around a stem (like opposite or whorled branching pattern species) concentrate significant stress and strain on the stem at the multiple stem - branch confluences. Separating a confluence horizontally and vertically allows a well-defended stem and structurally sound branch to grow.

In trees with distinctly whorled patterns of branch generation, like many gymnosperms, several aspects of classic design pruning must be modified. Branch distribution in these species should be visualized as: 1) will the tree be skirted almost to the ground; 2) how close together are the whorls; and, 3) how many branches per whorl currently exist. Always raise the live crown at least so foliage does not touch soil (consider placing foliage above the rain splash height), and so branches do not recline on the ground when wet during the growing season. If whorls are closer to each other than one mid-whorl stem diameter to each other, consider all branch removal on some whorls. Ideally prune to no more than two or three even spaced branches around the circumference at each whorl. Alternate vertical branch placements for each adjacent whorl. Figure 47.

Stuff Happens

Because trees, arborists, and past treatments are not perfect, stem - branch confluences may exist in non-ideal positions and represent significant tree resources. If confronted with confluences out of idealized positions, a minimum set of pruning criteria should be followed. The most extreme minimum vertical distance between branches should be at least four times the branch base diameter above and below each stem - branch confluence.

In a small tree with many tightly packed branches there can be many permutations of which branches to keep in optimizing crown aesthetic value, structural integrity and biological efficiency. No two neighboring branches should share the same vertical position (above or below the other) on the stem, or share the same longitudinal grain pathway (resource transport pathway). Estimating transport pathways are difficult especially with trees having slightly lopsided crowns generating crown twist (torque) held by significant spiral grain. No two neighboring branches should share the same circumferential area horizontally around the stem. Every branch must have its own resource control and delivery path, and its own stem position for structural stability.

Grow Low

The role of upper and crown edge branches are different from lower and interior branches. Because of chlorophyll and axillary pigment differences, coupled with different leaf architecture, trees gather all the resources possible throughout the above ground resource spaces they dominate. Upper and outer branches are designed to fill in and colonize new spaces rich in light. Lower and interior branches react to changing light resources by filling in old resource spaces within the crown. Lower branches are designed to capture light not fully utilized by top branches. Leaf area and respiring sapwood volume are proportionally different on lower and internal branches when compared with upper, full sun branches. Figure 48.

Low stem branches can function physiologically near the margin of net food production for long periods. As such, people argue removal of these branches make little difference to overall food and resource allocation processes in a tree. Changing internal allocation economics is but one potential impact of low branches. Marginal, low, and interior branches play a significant role in tree health and structure. Conservation of these branches is important, but these branches need to be controlled and prevented from dominating resource supply pathways. A healthy tree usually generates a growth control field to keep lower branches in check. Reduction pruning on these branches accomplishes the same thing.

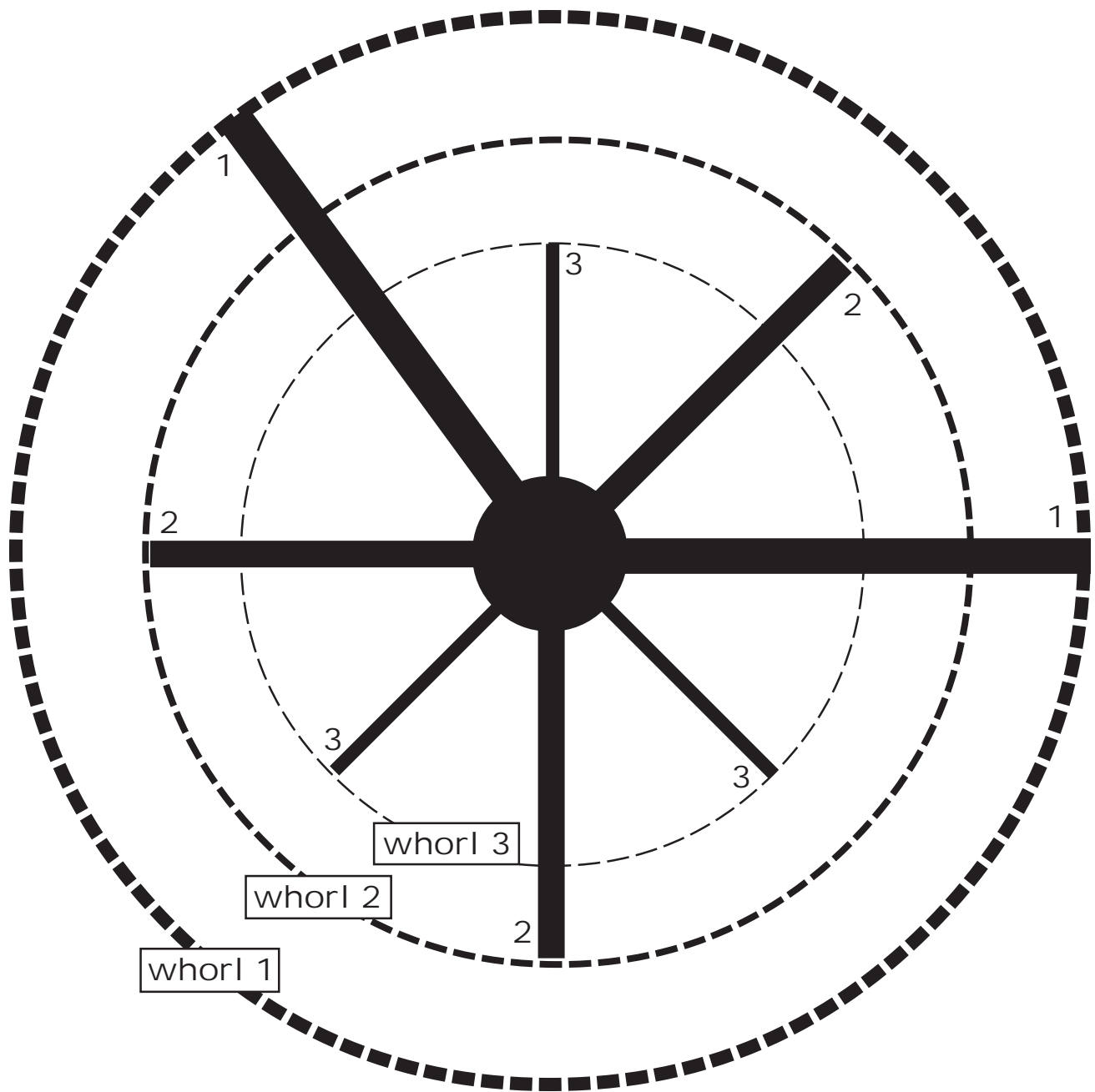

Figure 47: Diagram from above of a stem segment containing three branch whorls with branch patterns per whorl alternating to minimize shading of branches below. Whorl 1 is on the bottom and whorl 3 is at the top.

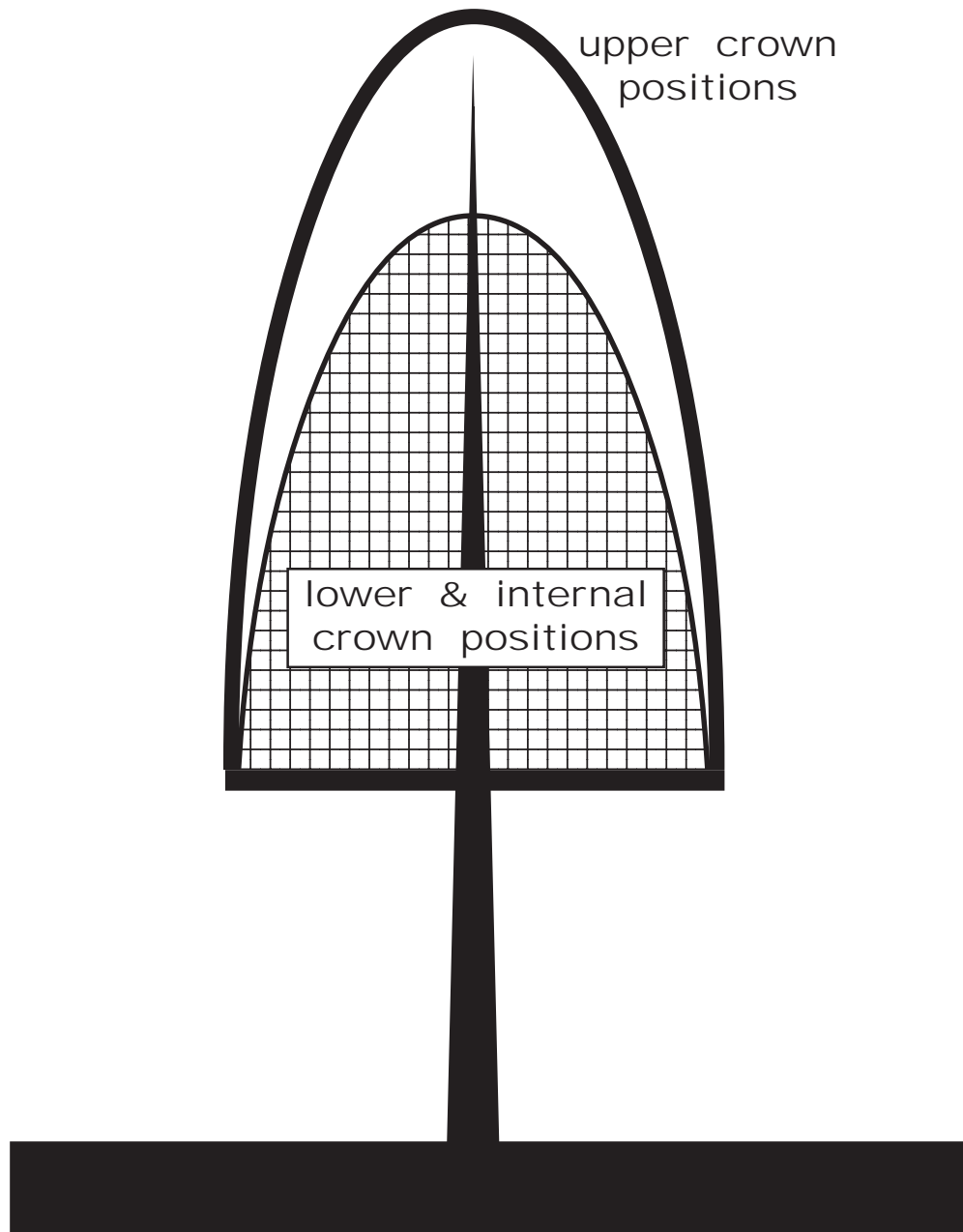

Figure 48: Diagram of crown positions in a tree where different leaf area, leaf productivity, and sapwood volume proportions exist.

Transient Values

Original branches, or later generated sprout-origin branches, along a stem in the lowest third of the tree are usually considered temporary or transient branches. Unfortunately, the drive to push for a clear trunk by raising the live crown quickly can disrupt food allocation, growth regulator distribution, root development and tree structural stability. These low branches are not the best food producers, but they still generate net production of food and growth regulators. Transient branches should be conserved and controlled.

Transient branches have great value in development of stem taper and root health. They are the driving force (literally the driven force) in sensing bend and torque stress, helping a tree effectively add new tissues to resist these stresses, while acting as shock absorber for mitigating storm wind loads. Low branches on a young tree will not exist in the mature tree. For example, branches which are 5 feet off the ground now in a 20 feet tall young tree usually will be removed eventually to yield an 75 feet tall mature tree with 25 feet of clear stem. Figure 49.

Skirting

Cultivating a natural aesthetic sometimes requires maintaining many low branches. A number of trees have a natural form with many lower branches and poor self-pruning (marginally productive branches held longer), and many of these tree species are evergreen. In trees intended to be skirted (low branches maintained) and not clear-stemmed, there are two interacting concerns -- branches should not have ground contact and prevention of branch damage from landscape maintenance equipment. Slight crown raising on these trees can improve health and reduce damage impacts.

Do NOT use a pruning prescription as an excuse for raising the live crown on species such as holly (*Ilex* spp), Southern magnolia (*Magnolia*), spruce (*Picea* spp.), fir (*Abies* spp.), and other naturally skirted tree forms. Raise low skirted trees to only the first or second whorl, or first few branches, and then stop raising. Mulch, fence, and/or defend low branches from mowers, trimmers and pedestrians.

Crown Base

Branch autonomy processes in a tree dictate each branch must produce enough food for itself and extra to transport to the stem and roots below. When branches do not produce this net amount of food, they are compartmentalized off (self-pruning or cladoptosis). If every branch is producing extra food to transport out to the stem and roots along with associated growth regulators, the transport stream of growth materials moving downward in the phloem is greatest at the base of the live crown.

The base of the live crown has a large concentration of food and growth regulators passing through, and is a center for stem reactions to structural load changes. The cambium / ray junctures act as mechanical sensors which help determine the mix of wood components developed to support the tree crown. The base of the living crown is where the most rapid diameter growth in a tree occurs.

Upward Bound

As branches are pruned (or self prune), the base of the live crown moves upward on a stem. As the position of the live crown base moves upward over stem tissue, rapid growth and development take place. The longer the live crown is in one location, the greater growth that stem area undergoes. If crown raising pushes the live crown base upwards too quickly, the stem fails to structurally develop as effectively in response to yearly wind conditions and gravity loads. The faster the live crown passes through a stem area, the less stem taper develops. Once the live crown base has passed upward, it is difficult to effectively retrofit the stem for new stresses and strains.

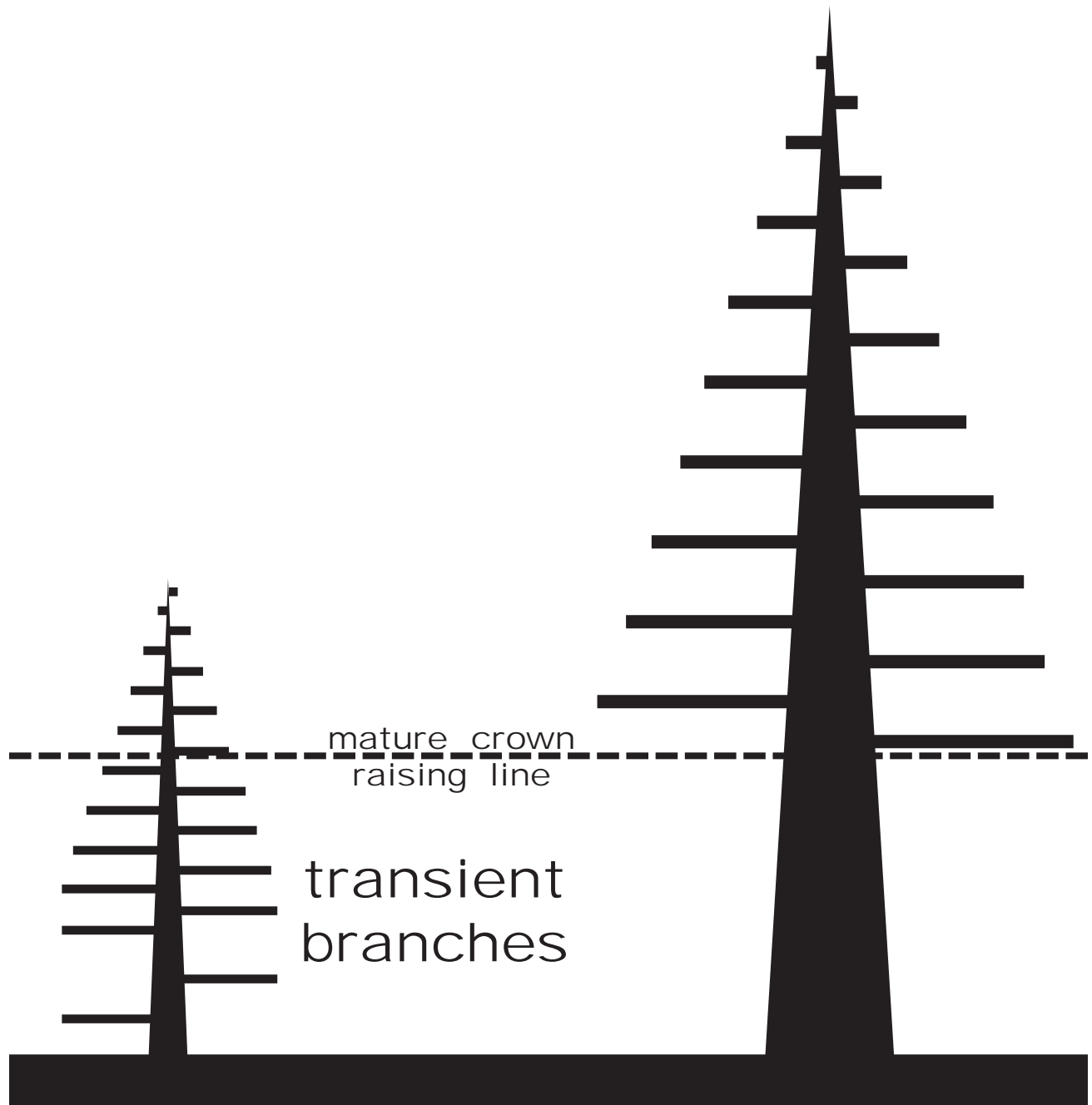

Figure 49: Diagrammatic example of transient branches on a young tree growing from a height above the ground which will require their removal as the tree grows taller.

For strong stems and branches, it is critical the living crown base is moved gradually up the stem over time. In some skirted species, the live crown base never moves significantly. For trees with crowns raised to present a clear stem, a slow ascent is needed to develop taper and resistance to bending and twist (torque). The position and movement of the live crown base is a key management marker in design of a strong and efficient tree. Changing or maintaining the live crown base is how a tree health care specialist manipulates aesthetic values, structural integrity and biological efficiency in a tree.

Crown Raising

There are some circumstances which may not meet, or are ever intended to meet, idealized proportions. In these cases, patience must be used in how gradual crown raising progresses. Figure 50 provides the maximum crown raising for any given live crown ratio (Coder Crown Raising Dose Assessment). Note for trees with small live crown ratios, the maximum per year raising which can be effectively adjusted to is quite small on a height basis.

For example from Figure 50, a tree with 33% live crown should not be raised more than 1/16th (6%) of live crown per pruning cycle. The less crown, the less food and growth regulators generated, reducing the ability of a tree to react to change. Ideally, a healthy tree with a live crown ratio of 66% should be able to sustain up to 1/8 (~13%) of the live crown removal in any pruning cycle. The larger the crown (and everything else being equal), the more accepting a tree is physiologically to productive crown loss. Healthy trees with 100% live crown ratios should be able to effectively react to crown raising up to 1/4 (25%) of living crown height in any pruning cycle.

The base of the living crown and its rapid growth create wood in positions to resist mechanical loads. Stem taper is essential for allowing trees to withstand lateral wind loads and control sway. In addition, the diameter of a tree must continue to grow at a much greater rate in proportion to height growth to maintain the same stem strength in resisting bending and twist. Figure 51 demonstrates the need for greater proportional diameter increases with increases in height. The key point is the live crown base must be allowed to develop a strong tree by building diameter and a well-tapered shape. Do not push crown raising too fast.

Heartwood Exposure

Many examinations of pruning and mechanical injuries in trees have shown small, shallow wounds are much easier for trees to effectively react to than wounds small in area but deep. Many tree health care specialists have at times misinterpreted this research. Depth of injury is not about the number of inches into the tree which damage extends. A deep wound is one that reaches into the heartwood, whether the stem is three inches in diameter or thirty inches. Depth of injury in a tree concerns the number of annual growth increments breached and the ability of the surrounding cells to react to injury. Shallow wounds remain entirely surrounded by sapwood.

One of the most important issues in pruning is to always make cuts which cross 100% sapwood. (Note: Do not confuse a large pith with heartwood.) Figure 52. Do not make cuts into or across heartwood, as this would be a deep injury and difficult for a tree to react to effectively. Accumulation of heartwood exposure on pruning wounds can be devastating over time. It is not just the large diameter branches, but all heartwood containing branches regardless of size that can present defensive problems for a tree. Even small, slow growing branches may have heartwood at their core, and exposing heartwood can signify long term structural and biological problems. Figure 53 provides a graphical definition of deep versus shallow – sapwood versus heartwood exposing -- pruning cuts.

How Bad?

Figure 54 provides a risk assessment guide for heartwood exposure (Coder Heartwood Exposure on Pruning Wounds Assessment). Heartwood exposures should be minimized in a tree. Mini-

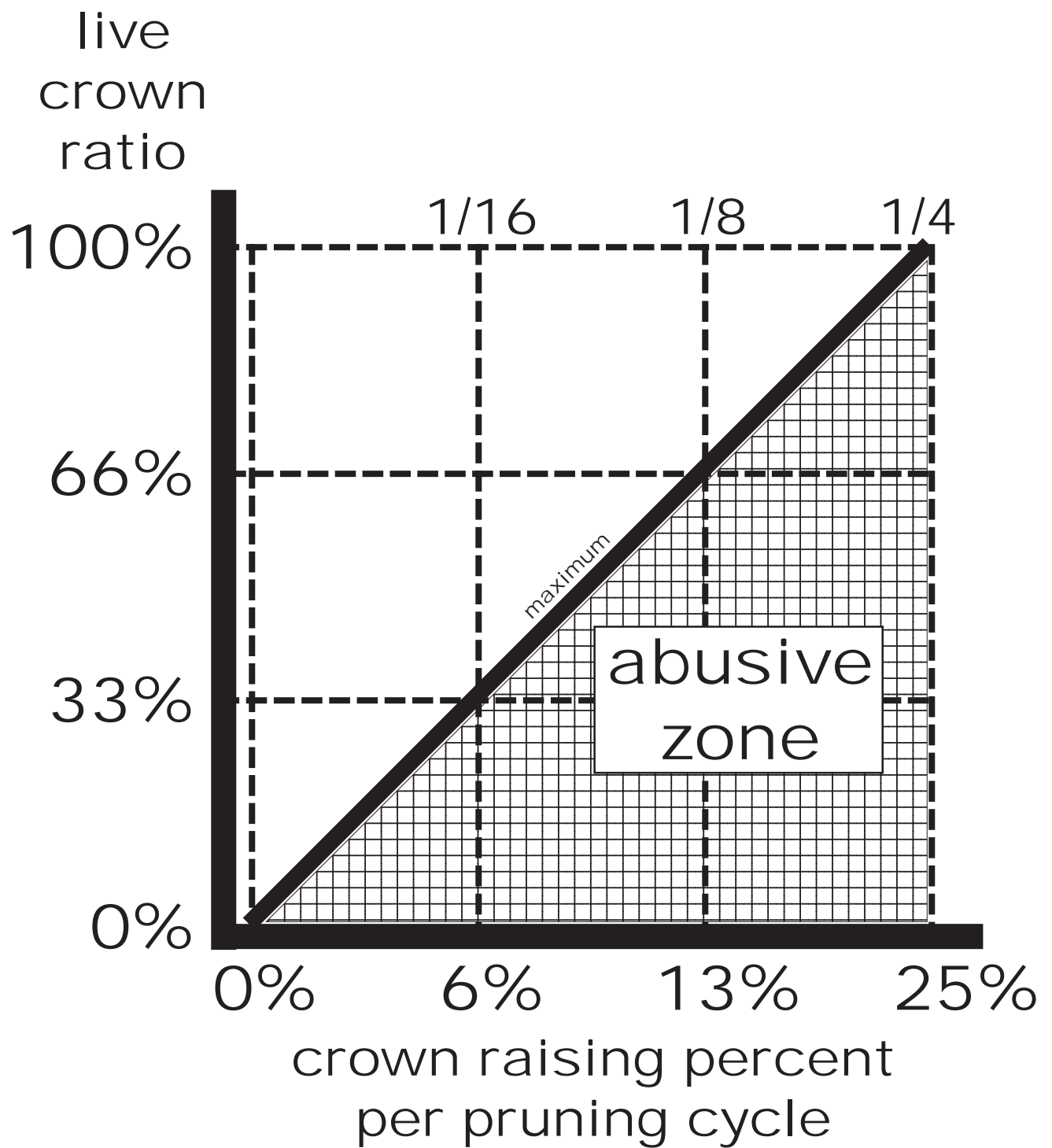

Figure 50: Coder Crown Raising Dose Assessment per pruning cycle for demonstrating potential crown raising abuse. Graph is the percent of live crown (height basis) that can be removed, if warranted, every pruning cycle (not less than every two years) in a crown raising process.

increase in
relative
tree height

100

80

60

40

20

0

20

40

60

80

100

increase in relative
tree diameter

$$1.2 \times \text{RELATIVE TREE HEIGHT INCREASE PERCENT} = \text{RELATIVE STEM DIAMETER INCREASE PERCENT}$$

Figure 51: The increase in height and diameter of a tree to maintain a similar proportional strength level (resistance to bending and torque (twist)).

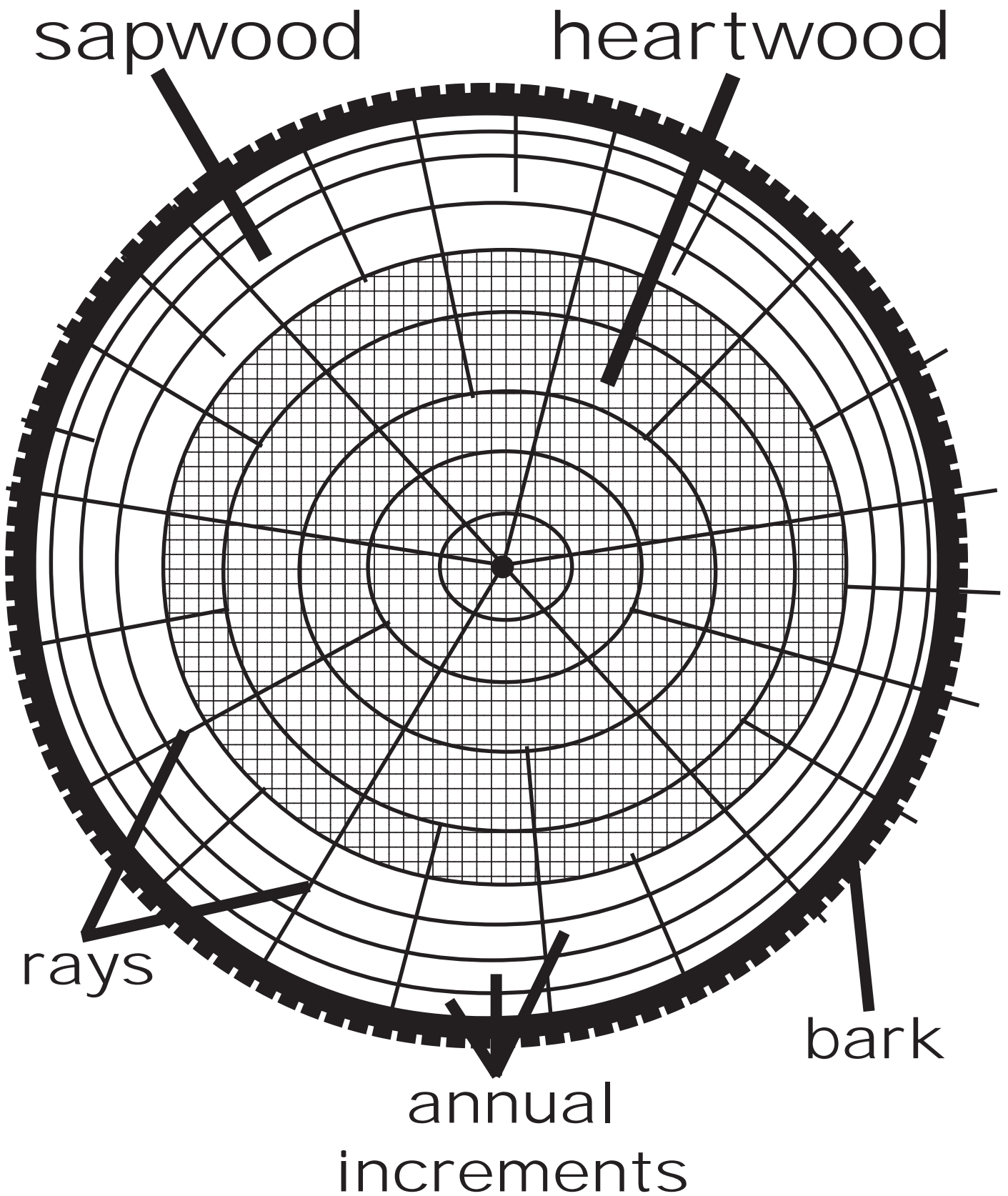

Figure 52: Diagram of a stem cross-section showing sapwood and heartwood (shaded).

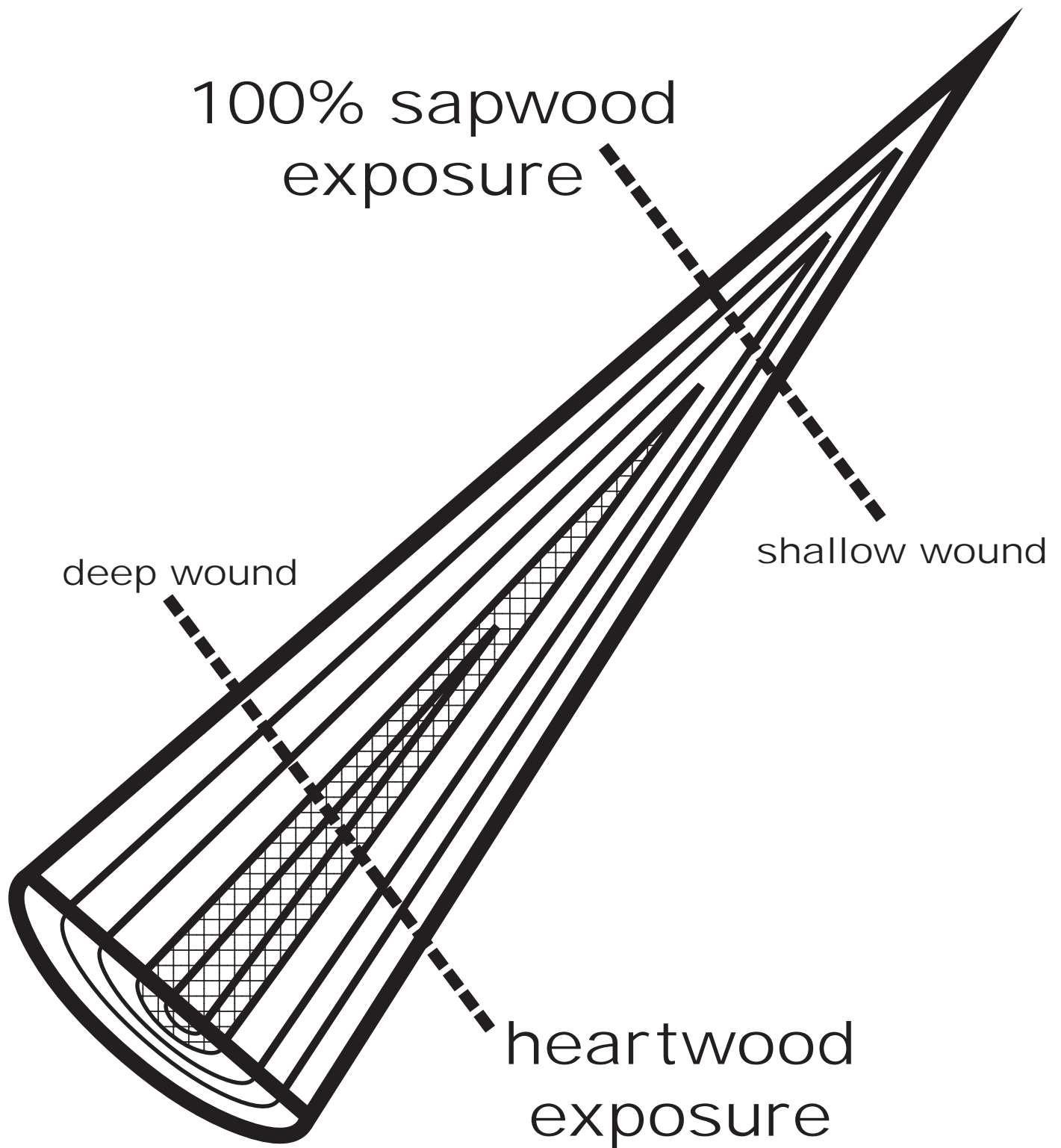

Figure 53: Diagram of a deep cut and a shallow cut using heartwood exposure to gauge relative wound depth. Note this diagram is an example of a deep and shallow pruning wound -- it is assumed a proper nodal pruning cut will be made.

CODER HEARTWOOD EXPOSURE ON PRUNING WOUNDS ASSESSMENT

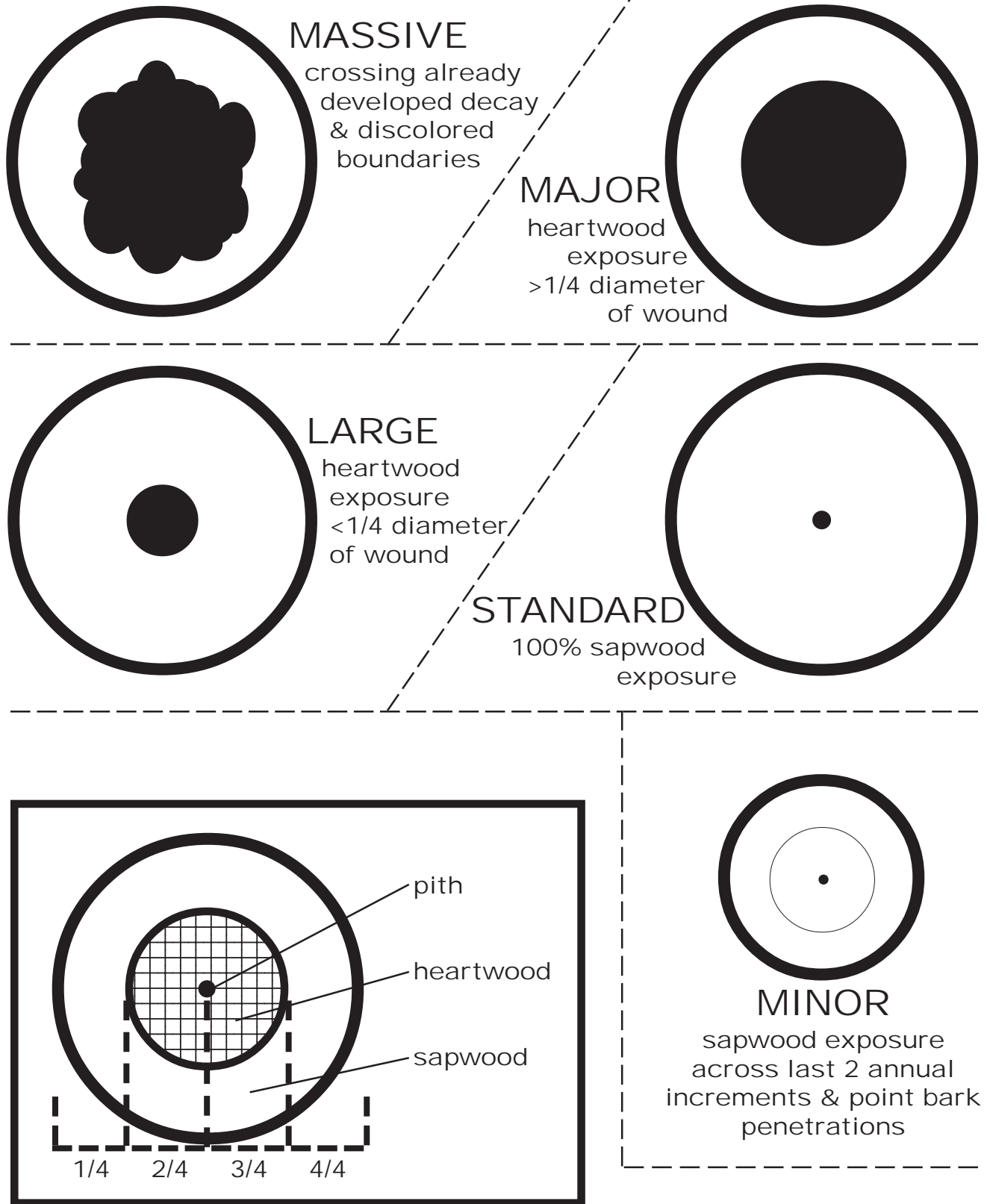

Figure 54: Diagrams describing the five types of branch pruning wounds using sapwood and heartwood exposures from wound faces.

mize heartwood exposure for each pruning event, allowing time for a tree to properly react and adjust to deep injuries. A major concern is there are few ways of judging if a pruning cut will show 100% sapwood exposure until the cut is completed. Once the wound is made, heartwood exposure can be assessed. Table 2 lists the number of pruning wounds a tree should sustain by heartwood and sapwood exposure type for each pruning cycle.

Deep pruning wounds exposing significant amounts of heartwood area demonstrate how these branches should have been cut much earlier when the branch was small and more effective in dealing with wounding. In this case, pruning was delayed too long. Once a pruning prescription is applied, a continual assessment of the amount of heartwood exposed should be tallied. Once too much heartwood is exposed, pruning should be terminated for this growing season. Skip one full growing season before pruning again. Brutalizing a tree with massive heartwood exposures from a few large cuts, or many small cuts, is not acceptable.

Transport Stress

Research on tree aging shows a major component in age on-set tree stress is the increasing number of nodes between leaf and stem base, and the complexity of the route water and essential elements must pass to reach the leaf. The more nodes between the source of gathered resources and sink (point of use), the greater chronic transport stress within a tree. A tree minimizes this type of stress through branch and twig abscission or self pruning. Trees maintain only a limited number of branch orders over time.

If every growing season produced a successful new lateral twig off of last year's lateral twig, by year fifty there would be fifty branch orders – and fifty twig and branch nodes between the stem and farthest twig tip. Figure 55 presents a diagram showing nine branch orders from the stem. If branch orders are counted, most trees maintain no more than 5-9 branch orders on lower branches, and only 3-4 near tree tops. The more stressful the site, especially for soil resource space and water resources, the trend is for fewer branch orders to be maintained. Transport stress slows or disrupts photosynthesis, nitrogen compound delivery, and use of stored food.

Count & Reduce

To minimize chronic transport stress at an early age, prune to eliminate higher order branches and twigs, leaving the remaining twigs biologically effective in generating photosynthate and growth regulators. A pruning prescription would simplify total transport path length to 4-6 branch orders. This minimal transport path acts as an accelerated natural process (cladogenesis) minimizing transport stress. The stress aging of young and middle aged trees can be significantly reduced by this process.

Branch Dominance

The feedback loop in a branch for success involves continued large pulses of bud-produced growth regulators (principally auxin). These pulses define root regulator pathways essential for water and essential element delivery. Water and elements are used to generate more food, which in turn is shipped out to the roots along established growth regulation defined highways. The roots reciprocally, supply more raw materials to those successful food producing areas of the stem. Around the outside of the crown, dominant and active buds on major branch tips control both lateral bud growth and twig resource delivery pathways behind and below the branch tips.

Lateral buds, branches and twigs are partially controlled by lack of resources associated with lack of growth regulator signaling. The terminal and active buds manage and control branch resources, and so, the buds and twigs farther down the branch toward the stem. There are several times a year (most notably

Table 2: Maximum number of pruning wounds to be applied to a single tree by wound type in one pruning cycle. See Figure 54 for definitions.

CODER HEARTWOOD EXPOSURE ON PRUNING WOUNDS ASSESSMENT

pruning wound type	maximum number of pruning wounds to single tree
massive	1
major	3
large	7
standard	15
minor	31

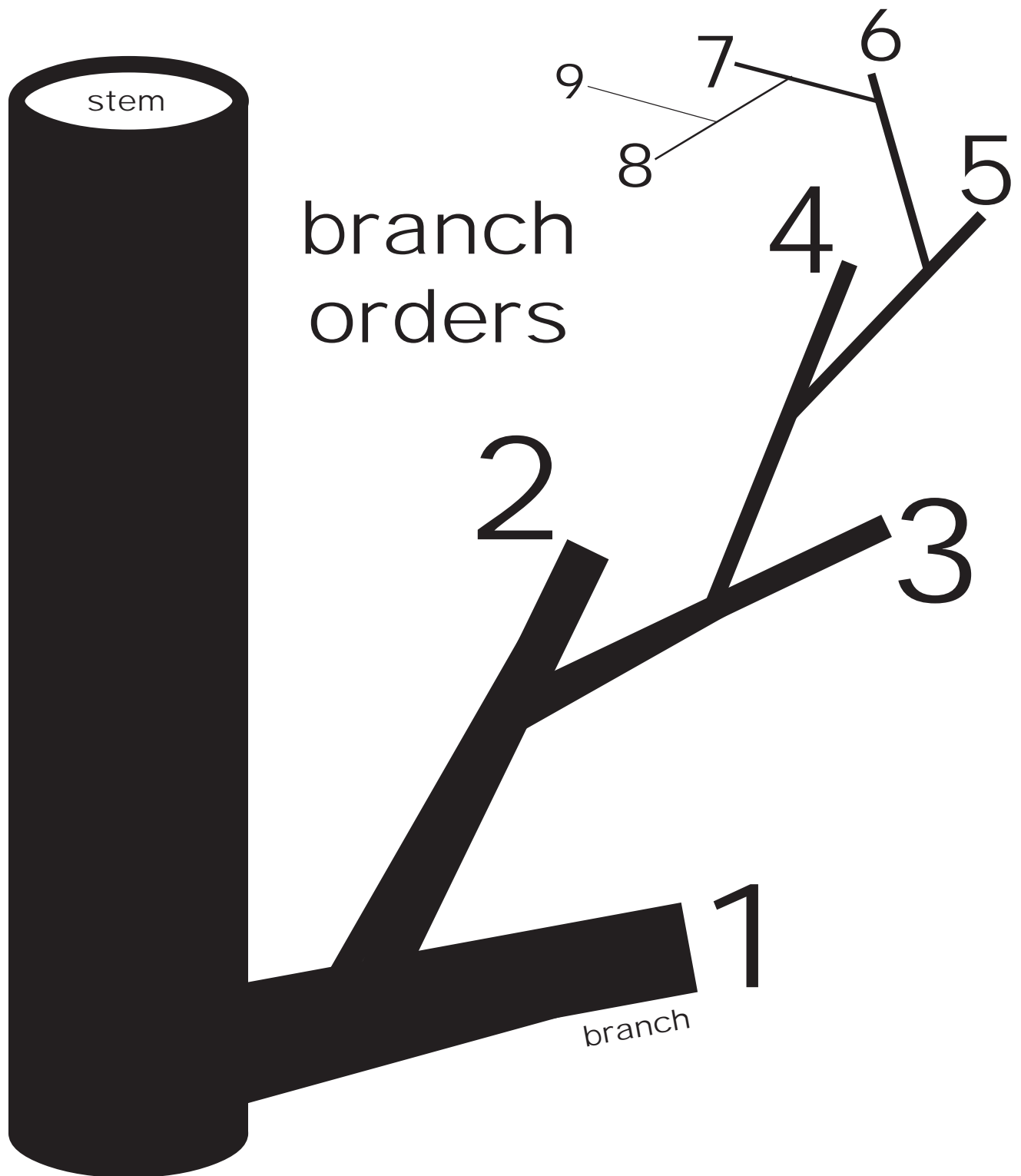

Figure 55: Diagram demonstrating how branch orders are counted. This set of branches and twigs have 9 (nine) branch orders. More branch orders signify more transport resistance and resource stress.

in the early senescence period of fall) when crown control and dormancy processes leave lateral buds, twigs and branches free from most controls by terminal buds for short periods of time. Dormant buds, lower twigs on a branch, and lower branches on a stem can pilfer additional resources from transport and storage systems, and grow.

Coup d'etat!

As the tree top slows down in growth material production and prepares for winter, and the roots are still active, lateral tissues can become more active for a period of time (released from control / dominance). Dormant buds can be released in positions where light resources are available. If lower branches attain better light resources by elongation and better connections to raw material transport paths, a lower branch can start to grow, control resource space, and expand its dominance. Stressful environmental conditions and damage can also act to constrain crown terminals which can lead to lateral branch and twig growth, and dormant bud release.

The long term problems of lower sprouts, twigs, and branches attaining dominance in a tree can lead to top or upper branch stress and loss, as well as disrupting transport and defensive capabilities. Newly released sprouts from dormant (latent) buds should be removed within one growing season. To manage tree domination and transport control by lower branches, aggressive branches should be abridged to shade. (Note: branch reduction NOT removal.) Abridging to shade of terminal portions of aggressive twigs and branches, plus the next three lateral buds or twig terminals in angiosperms (or the single twig terminal area in gymnosperms), will help upper branches retain/regain firm control. Because transport pathway success accelerates success, several small abridgments over several pruning cycles will usually be needed. Abridge lower aggressive twigs or branches back enough so they are shaded. Shading calms all growth feedback processes.

Dominating

As discussed earlier, lower and side branches should not be removed unless it is absolutely essential or the branch base diameter is becoming too large for the stem. Abridging the branch to shade allows food and growth regulation production to continue at a limited level while maintaining single trunk dominance. Abridging, not removing, aggressive branches allows internal consolidation of transport paths and branch resources. This abridgment to shade is of value to the whole tree under our management objectives. "Shorten not remove" is a key learning point about pruning lower branches.

Pruning Time

If a tree is healthy with plenty of stored food, timing of pruning is not as critical as when trees are stressed and constrained by site resources. Unfortunately, most shade and street trees have resource gathering, control, and transport problems which make timing of pruning more important. There are three physiologically related time targets within an annual growth cycle of a tree when pruning should NOT be completed. Avoid the growth period from first noticeable bud change in Spring until leaves have fully expanded. Do not prune in the heat of summer (high temperatures above 85°F). Later, avoid the leaf senescence season from first yellowing (start of foliage color change) in Fall until all shades of green (or green islands or patches in leaves) have been completely lost. Obviously, this last temporal target is for deciduous hardwoods. These hardwood trees, if in full sun, can be used as ecological sensors for knowing when to treat surrounding evergreen gymnosperms and angiosperms. Figure 56.

Prescribe pruning for after full leaf expansion in late Spring and early Summer, and in the dormant season. Care must be taken with various species initiating bud changes in early Spring to assure no pruning in this bud change period. Avoid late dormant season pruning in species that generate large root water pressures to minimize wound weeping or oozing. It is critical that late Spring / early Summer pruning does

tree activity &
growth regulator
ratios

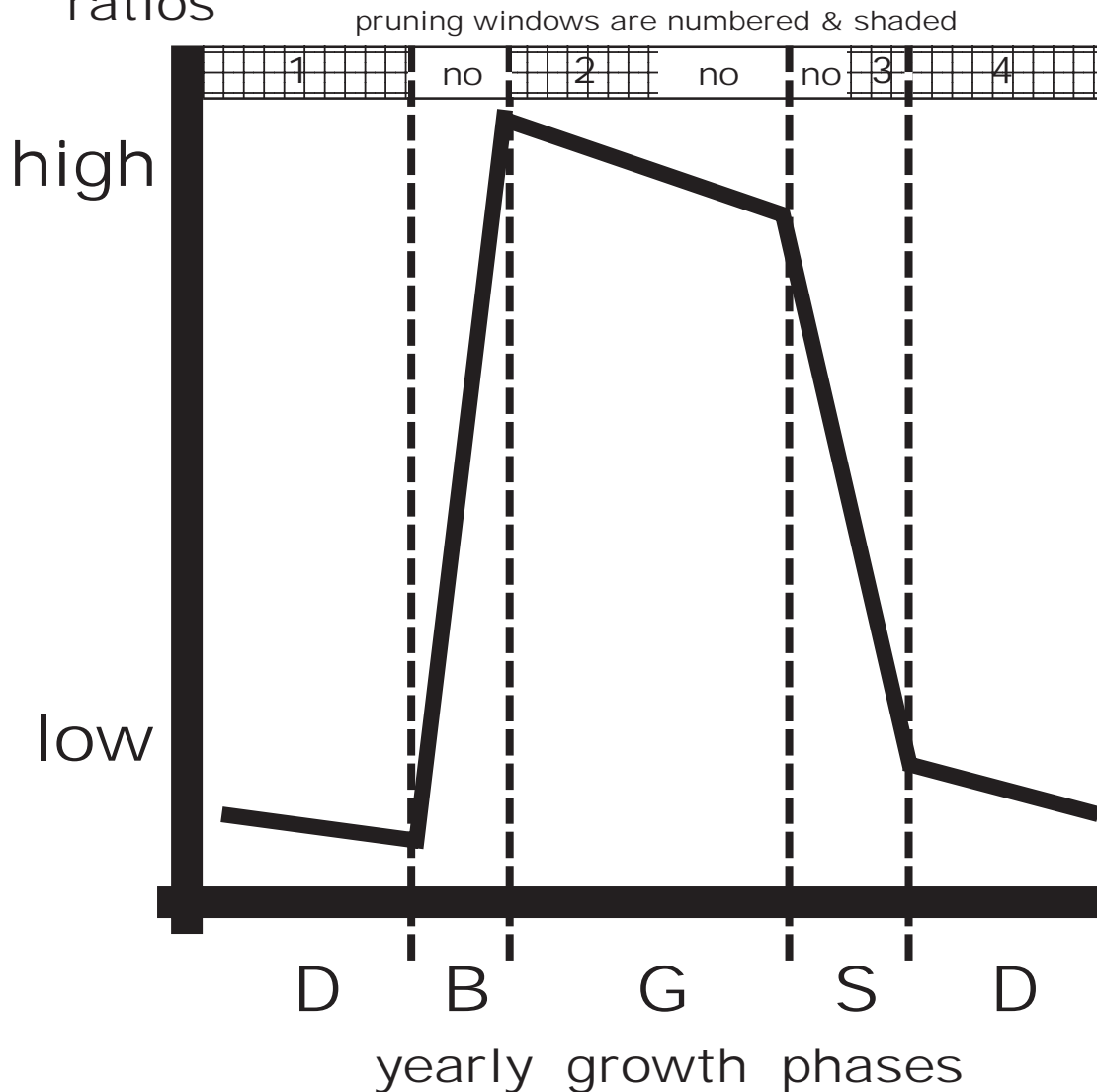

Figure 56: Graphical description for timing of pruning prescription applications. D = dormant; B = bud & leaf expansion; G = growth phase; S = senescence. There are four pruning windows (shaded & numbered) and three times when pruning is not acceptable (“no”).

not facilitate pest success. In some parts of the continent and in some tree species, the chilled temperatures of late dormant season pruning is the only choice because of pest problems. For example, the Southern yellow pines (*Pinus* spp.) should only be pruned in the late dormant season when daily high temperatures are below 65°F due to bark beetle concerns. Growing season pruning remains a best management practice in most places for most species.

How Often?

Due to resource collection and growth rates of young, active trees on good sites, a short pruning cycle should be installed after establishment. Expect to prune trees every two years for the first three times (a total of six years). These pruning events should concentrate on removing problems and helping the tree become aesthetically pleasing, biologically efficient and mechanically sound. After the initial phase of two year cycles, shift into a three year pruning cycle.

It is important to gauge pruning cycle timing by the size of branches relative to stem sizes at the each stem - branch confluence. All branches should be conserved if they are less than 1/2 (ideally 1/3) the diameter of the stem from where they grow. The absence of heartwood revealed in pruning cuts is also important in gauging pruning cycle. Strive to have 100% sapwood pruning wounds. Lengthen or shorten the pruning cycle to assure no heartwood exposure and no codominant branch formation.

Getting To Dose

The amount of pruning a tree can sustain at any one time or event can be estimated by experienced tree health care professionals. Crown raising limits and heartwood exposure assessments can suggest how much to prune a young healthy tree. Most means of determining pruning dose try and estimate volume, density, or surface area of leaves. The more leaves a tree sustains over time, the greater chance it will be productive. Health and productivity of individual leaves and branches are difficult to estimate, allowing pruning dose estimates to be filled with errors.

One way of estimating leaf number and activity is by examining the non-photosynthetic living tissue supported by leaves. These tissues are generically called sapwood and depend upon leaves for food and in turn, support leaves by defending and maintaining growth material supply transport systems. Sapwood must be fed by leaf productivity. Low leaf productivity increases heartwood volume and decreases sapwood volume. Greater leaf productivity sustains more sapwood. Depending upon species and site, there is a relationship between leaf productivity and sapwood area.

Sapwood

The sapwood area in a branch or stem supported by and supporting a set of leaves can be measured by increment core, by recording diameters of pruning wounds, and by estimating growth rates. As trees grow larger, more sapwood is generated and less leaves per unit of sapwood are sustained. The longer the branch and the larger branch diameter, the less leaves per sapwood sustained. Sapwood volume, as estimated by its cross-sectional area can be used as a simple assessment of the leaves present.

For example from research literature, the proportion of tree leaf area to sapwood area (m^2/cm^2) is 0.4 for redwood (*Sequoia*), 0.67 for cherrybark oak (*Quercus*), 0.24 for green ash (*Fraxinus*), 0.5 and 0.41 for eucalyptus (*Eucalyptus*). [change units of measure: $\text{m}^2/\text{cm}^2 \times 69.4 = \text{ft}^2/\text{in}^2$]. The proportion of leaf weight to sapwood area (kg/cm^2) was found in one study to be 0.12. The proportion of leaf area to sapwood area divided by tree diameter ($(\text{m}^2/\text{m}^2)/\text{mm}$) was found in one study to be 2.6. All of these proportions from research represent a highly limited set of species, individual trees, and sites, but demonstrate how leaves and their productivity can be estimated by other tree measures.

Living Area

Clearly one usable ratio in trees is leaf area to sapwood area, which acts as an approximation of tree (i.e. leaf) productivity. The more leaves, and the more productive each remains, the greater the cross-sectional area of sapwood sustained. As trees grow, especially under harsh conditions, the amount of sapwood area can decline while the amount of heartwood area can increase. Measuring sapwood area estimates the productivity of the branch or stem above. Table 3 provides sapwood area in square inches for various branch and stem diameters and with varying amounts of sapwood visible outside the heartwood core. Note this table is only effective for species with clearly visible heartwood, and for circumstances where discolored wood from injury and decay can be differentiated from true heartwood.

For example from Table 3, a 10 inch diameter stem has about 79 square inches of sapwood area if the entire cross-section is sapwood (100% sapwood). If this tree is cored and is found to have only 1 inch of sapwood around the outside of a heartwood core, there is only about 29 square inches of sapwood area. Additionally from Table 3, if a branch 4 inches in diameter (branch diameter not branch collar diameter) is pruned and is 100% sapwood, it would have 13 square inches of sapwood area.

Pruning Dose

The amount of pruning allowed in a tree for any pruning cycle can be estimated by using the Coder Sapwood Area Pruning Dose Assessment formula. The formula calculates the cumulative amount of sapwood area pruned off the tree from branches compared with the amount of sapwood area present in the stem. The Coder Sapwood Area Assessment formula is: tree sapwood area in square inches multiplied by 0.334. The result is divided by a sum of all branch sapwood areas in square inches pruned each multiplied by their crown position value within a tree. Crown position value is a multiplier for branch sapwood area based upon whether the branch was in the highest crown position, lowest or internal crown position, or was a new sprout.

The final result is the pruning cycle dose (PCD). If the PCD is greater than 1 (one) then the pruning was within biologically sustainable limits. If the PCD is less than 1 then pruning exceeded biological limits, stressed the tree, and is a treatment overdose. See Figure 57 for the formula and example pruning dose calculation. [Conversions: 1 square inch = 6.45 square centimeters; 1 inch = 2.54 centimeters; 1 centimeter = 0.394 inches; 1 foot = 0.305 meter; 1 meter = 3.281 feet; 1 meter = 39.37 inches.]

Wound Wounds

Few transformations in tree health care have been as comprehensive in the last 40 years as pruning wound treatments. From the past, when heavy, opaque, petroleum based salves were slathered onto new pruning wounds, to newer research supporting open oxidation and drying concepts, wound treatments have been viewed from every angle.

Research shows pruning paints of whatever variety, application method, ingredients, or formulation do not prevent decay or aid in natural defensive zone effectiveness. Heavy coats of different pruning paints have been shown to accelerate decay behind the pruning wound surface by aiding decay organisms. No pruning paint has been consistently cited as helping in the quick and effective closure of pruning wounds.

Concealer

In most circumstances, wound paints are cosmetic at best and a facilitator of tree damage at worst. Best management practices for pruning wounds is to leave them open to the environment which will oxidize the wound surface, dry and illuminate the surface, and initiate a strong compartmentalization response. Aesthetic concerns about visible wounds on trees can be solved by use of tree wound paint

Table 3: Sapwood area in square inches for tree or branch diameters (inches) for various sapwood depths (inches). [1 square inch = 6.45 square centimeters; 1 inch = 2.54 centimeters; 1 centimeter = 0.394 inches.]

diameter (inches)	sapwood depth to heartwood (inches)								100% sapwood
	0.5"	1"	1.5"	2"	2.5"	3"	3.5"	4"	
0.2 in									0.03
0.4									0.13
0.6									0.28
0.8	--								0.5
1	--	--							0.8
2	2 in ²	--	--						3
3	4	6	--	--					7
4	6	10	3	--	--				13
5	7	13	17	19	--	--			20
6	8	15	21	25	27	--	--		28
7	11	19	26	32	36	38	--	--	39
8	11	22	30	37	43	47	49	--	50
9	14	25	36	44	51	57	61	63	64
10	15	29	40	51	59	66	72	76	79
11	16	31	45	56	67	75	82	88	95
12	18	34	49	63	74	85	93	100	113
13	20	38	54	69	83	94	105	113	133
14	21	41	59	75	90	104	115	126	154
15	23	44	64	82	98	113	127	138	177
16	24	47	68	88	106	122	137	151	201
17	26	50	73	94	114	132	148	163	227
18	27	53	77	100	121	141	159	175	254
19	29	56	82	106	129	150	170	188	283
20	31	60	87	113	137	160	181	201	314
21	32	63	92	119	145	169	192	213	346
22	34	66	97	126	153	179	203	226	380
23	35	69	101	132	161	188	214	238	415
24	37	72	106	138	169	198	225	251	452
25	39	76	111	145	177	208	237	264	491
26	40	79	116	151	185	217	248	277	531
27	41	81	120	157	192	226	258	289	572
28	43	84	124	163	200	235	269	301	615
29	45	88	129	169	208	245	280	314	660
30 in	47	92	135	176	216	255	292	327in ²	707in ²

Figure 57: Amount of pruning allowed in one pruning cycle based upon sapwood area measures.

[1 square inch = 6.45 square centimeters; 1 inch = 2.54 centimeters; 1 centimeter = 0.394 inches.]

Coder Sapwood Area Pruning Dose Assessment

tree sapwood area in square inches X 0.334

sum of all
[branch sapwood area pruned X
crown position value]

1 = <1 year old sprouts
2 = lowest & internal
crown positions
3 = highest crown positions

=

PRUNING CYCLE DOSE or PCD

> 1.0 = within biological limits
< 1.0 = exceeded biological limits -- stress

Example: 10" diameter tree (DBH) (from Table 3)

diameter branch pruned	sapwood area	crown position	crown position value	calculated values
3"	7	low	2	14
2"	3	low	2	6
1"	.8	low	2	1.6
1"	.8	high	3	2.4
0.6"	.28	high	3	0.84
0.4"	.13	sprout	1	0.13
				[sum of all = 23.37 in ²]

If tree is:

100% sapwood tree:	pruning cycle dose =	1.13
3" sapwood in tree:	pruning cycle dose =	0.94 (6% overdose)
1" sapwood in tree:	pruning cycle dose =	0.41 (59% overdose)

without a petroleum or ammonia-based carrier to lightly color and hide the wound. Do not use house paint (either oil based or latex based) as these products will damage living tree cells around the wound, essentially expanding the wound and causing more damage.

Pruning wound treatments do have value in some situations. Some specially designed, non-phyto-toxic wound paints or covers have been found to be effective in preventing select vascular diseases spread by wound attacking insects in the growing season. Special use wound treatments are prescribed solutions to some tree health care issues.

Stay Clean

Pruning provides several opportunities for further tree health problems. The two most noticeable problems are the removed remains of living tree tissues, and the newly opened wound site.

Dying and newly dead tissues recently pruned from trees are filled with the essentials of life. These materials, if still in a as-pruned form, contain many essential elements and nutrients needed by micro- and macro-organisms. All materials removed should be: physically taken away from the pruned tree; chipped into much smaller pieces and left to quickly dry or compost; chipped into a transportable form for bagging; or, quickly cut-up and removed from the site.

Pruning wounds must be left free of dangling, crushed, cracked, abraded, or torn tissues. Bark must be firmly and completely attached all the way around a wound. A sharp saw (and a sharp user) leaves the best defensible wound for a tree. Do not rub soil on wound sites. Ideally, pruning wounds should not be positioned to accumulate water and debris, scarred or scored, or covered. Cold (hand) pruning saws and shears should be cleaned free of cutting debris and disinfected often, especially if treating a tree with known disease problems. Hot saws / powered saws which generate friction heat should be cleaned of cutting debris often and occasionally disinfected. Disinfect cutting surfaces and anything which touches wound surfaces with ethyl alcohol (not rubbing alcohol) and allow the surface to completely dry before use.

Conclusions

The basics of tree pruning are easy to learn but are difficult to apply across many species, forms, and field situations. A few summary statements can be emphasized. Key among these are:

- Prescribe pruning techniques based upon a whole tree concept for attaining an aesthetically pleasing, biologically efficient, and structurally sound tree.
- Keep to classical design proportions in most situations.
- Manipulate tree crowns by managing branch sizes and allocating resource space.
- Generate only small sized, shallow wounds with minimal heartwood exposure.
- Generate only nodal, targeted cuts which help a tree defend stem - branch confluence areas.
- Avoid use of growth disrupting or pest facilitating treatments on wounds.
- No internode, tipping, topping, or hedging cuts!
- Always cut back to shaded branch unions within crowns.
- Patience! Gain tree values through thoughtful and prescribed pruning applied over years – do not rush or over-apply pruning prescriptions.

This pruning foundations educational process should be used for developing your own pruning specifications and standards. Once fundamentals are appreciated, effective and informed pruning using sharp pruning tools well-handled can conserve and add value to trees.